

Document downloaded from: <https://www.mainstaymedical.com>

Document Information:

Device Name: ReActiv8 System

Document/Label Type: Implant and Programming Manual

Country: CE

Language: English

Revision: B

Filename: ReActiv8® System-Implant and Programming Manual-CE-English-Rev B.pdf

ReActiv8[®]

Implantable Electrical Stimulation System

Implant and Programming Manual

Model 5100 Implantable Pulse Generator

Model 8145 / 8165 Implantable Stimulation Leads

Model 7000 Activator

Model 4000 Magnet

Model 5500 Torque Wrench

Model 6000 Programmer Wand

Model 65X0/75X0 ReActiv8 Programmer



Mainstay Medical Limited
Clonmel House
Forster Way
Swords, Co. Dublin, K67F2K3, Ireland

Internet: www.mainstaymedical.com
E-mail: contact@mainstaymedical.com
Tel.: +353 766 801428

UK Responsible Person:
ICON (LR) Limited
100 Longwater Avenue
Green Park, Reading RG2 6GP
Berkshire, United Kingdom

Mainstay Medical and ReActiv8 are registered marks of Mainstay Medical Limited.

This product, and methods of use thereof, is covered by one or more of the patents identified at www.mainstaymedical.com/patents. This webpage serves as notice under 35 U.S.C. § 287(a) of patent marking.

Copyright © 2025 by Mainstay Medical Limited. All Rights Reserved. No portion of this manual may be reproduced or transmitted in any form or by any means, electronic or mechanical, including photocopying, recording, or any information storage and retrieval systems, without the express written permission of Mainstay Medical Limited.

Table of Contents

Introduction	5
ReActiv8 Components	5
How To Use This Document	6
Training Requirements	6
Safety Information	7
Label Symbols	7
Battery Disposal Guidelines	9
Intended Purpose/Indications for Use	9
Contraindications	9
• Warnings	10
Electromagnetic interference (EMI)	10
Other	12
• Precautions	12
Electromagnetic Interference (EMI)	13
Electromagnetic interference (EMI) from household items	15
Target population	15
Sterilization, storage and handling	16
System components	17
System implant	19
Programming	19
Activator and Magnet	20
Limitations of use	20
Component Return and Disposal	21
Residual Risks and Potential Complications	22
Potential Benefits	23
Instructions to Patients	23
MRI Safety Information	24
Magnetic Resonance Imaging (MRI)	24
Device Description	25
ReActiv8 Overview	25
Implantable components of the ReActiv8 system	25
External components of the ReActiv8 system	25
ReActiv8 Implantable Pulse Generator (IPG)	25
ReActiv8 Leads	26
Lead Accessories	25
Lead Delivery System	27
Application Software and Programmer Wand	27
ReActiv8 Activator	28
ReActiv8 Magnet	28
Package Contents	28
ReActiv8 IPG kit	29
ReActiv8 Lead kit	29
ReActiv8 Activator kit	29
ReActiv8 Magnet kit	29

ReActiv8 Torque Wrench	29
ReActiv8 Programmer Wand	29
ReActiv8 Application Software	30
Product Materials	30
Implant Procedure	31
Implant Summary	31
Patient Preparation	31
Package Opening / Product Handling	31
Lead Placement	32
Creating the IPG Pocket	34
Tunnelling the Lead	35
Connecting and Implanting the IPG	36
Check System Integrity	37
Completing the Implant Procedure	38
Explant Procedure	39
Removing the IPG	39
Removing the Leads	39
Programming the ReActiv8 IPG	41
Introduction	41
Stimulation Parameters	41
Cycle and session	42
System Diagnostics Data Collection	44
Programmer Wand indicators	45
Preparing the ReActiv8 Programmer Wand and commercially available laptop computer for use	45
Logging into the ReActiv8 Application Software	45
Navigation, Parameters and Buttons	45
Main program tab	46
Command buttons	46
Parameter constraints, and warnings	47
Stimulation mode and configuration	48
Session parameters	49
Impedance logging	50
Temporary Program Tab	50
Temporary mode	50
Command buttons	51
Impedance Screen Tab	51
Command buttons	51
Data Review Tab	52
Command buttons	52
Data Graphs Tab	53
Command buttons	53
X-Axis time interval	53
Log Grid	53
Constraints window	53

Menu Bar	53
File menu	54
Tool bar	54
View menu	54
Tools menu	55
Log menu	55
Help menu	56
Information bar	56
Interrogation and IPG States	56
IPG States	57
Stimulation Testing	58
Interrogate the IPG	58
Verify IPG–Lead connections	58
Prepare for stimulation testing	58
Perform Threshold testing	58
Stimulation program verification	59
Permanently programming the selected parameters	59
Measure impedance and verify IPG time	60
Ending a programming session	60
Verify changes have been programmed	60
Review session history	60
Administering a session	60
Using the Activator and Magnet	60
Troubleshooting	61
Telemetry Related Troubleshooting.	61
Changing Programmable Parameters-Related Troubleshooting	62
Programmer Wand Troubleshooting	62
Activator and Magnet Troubleshooting	62
Service Information	63
Radio Equipment (RE)	64
Appendix A: ReActiv8 IPG Specifications	65
Appendix B: Programmer Wand Specifications	68
Appendix C: ReActiv8 Lead Specifications	69
Appendix D: Declarations	71
Index	76

Table of Figures

Figure 1: ReActiv8 Lead distal end showing electrodes, tines and end-cap	26
Figure 2: ReActiv8 Lead proximal end showing connector terminals and set-screw retainer	27
Figure 3: Suture sleeve	27
Figure 4: Activator	28
Figure 5: Stimulation waveform and rate	42
Figure 6: Stimulation Cycle	42
Figure 7: Stimulation Session	43
Figure 8: Example of Programmer Main Window	46
Figure 9: Stimulation configuration controls	49
Figure 10: Lead – proximal end	69
Figure 11: Lead – distal end	69
Figure 12: Lead dimensions – distal end	69

Table of Tables

Table 1: ReActiv8 IPG nominal mechanical and electrical specifications	65
Table 2: ReActiv8 IPG Programmable Parameters	65
Table 3: Battery indicators	66
Table 4: IPG Longevity	66
Table 5: Conditions for longevity calculations	67
Table 6: Programmer Wand nominal specifications	68
Table 7: Lead summary specification	70
Table 8: Lead materials	70
Table 9: Declarations – IPG and Activator Electromagnetic emissions	72
Table 10: Declarations – Programmer Wand Electromagnetic emissions	72
Table 11: Declarations – IPG and Activator Electromagnetic immunity	73
Table 12: Declarations – Programmer Wand Electromagnetic immunity	74
Table 13: Declarations – IPG, Programmer Wand and Activator Electromagnetic immunity	75

Introduction

ReActiv8 is an implantable electrical stimulation system designed to stimulate the medial branch of the dorsal ramus nerves to cause contractions of lumbar multifidus muscles. Clinical studies have shown that twice-daily sessions of repetitive contractions can improve back pain, reduce disability and restore function, and improve quality of life.

ReActiv8 Components

The implanted ReActiv8 components comprise ReActiv8 Implantable Pulse Generator (IPG) and two ReActiv8 stimulation leads, and suture sleeves. Each lead has a terminal at the proximal end which connects to the IPG, and electrodes at the distal end which deliver the electrical stimulation pulses to the medial branch of the dorsal ramus, such that electrical stimulation will cause contraction of the lumbar multifidus muscles. The provided implant tools facilitate placement of the electrodes.

Three external components can be used to interact with the IPG:

1. ReActiv8 Application Software and ReActiv8 Programmer Wand (used in conjunction with a commercially available laptop computer) used to program the stimulation parameters for the IPG.
2. ReActiv8 Activator, to start and stop a stimulation session.
3. ReActiv8 Magnet, to start or stop a session as a backup to the Activator.

NOTE: For Activator and Magnet instructions, refer to ReActiv8 User Manual.

How To Use This Document

Intended Users:

This Implant and Programming Manual describes the ReActiv8 implantable electrical stimulation system, and provides implant and programming instructions for healthcare professionals. Refer to the patient User Manual for instructions on controlling stimulation sessions with the Activator or Magnet.

The “ReActiv8 Implant and Programming Manual” consists of two main sections.

1. The “Implant procedure” section provides detailed instructions for the implantation of the leads and IPG.
2. The “Programming ReActiv8 IPG” section provides detailed instructions for programming the parameters controlling the stimulation and diagnostic functions.

Training Requirements

Physicians will be required to undergo training related to diagnosis, therapy indications, and implant techniques by qualified Mainstay personnel prior to implantation of the device.

Patients will undergo training by a qualified Mainstay representative on use of the therapy and its components upon device activation.

Safety Information

Carefully read all contraindications, warnings, precautions, considerations for patient selection and instructions before use. Follow all operating, maintenance, and installation procedures as described in this manual. Failure to do so may result in patient or operator harm.

Safety may be compromised if the procedures used to operate and maintain the ReActiv8 system are different than those specified in the manuals. Anyone who performs the procedures must be appropriately trained and qualified.

Label Symbols



CE mark of conformity with the identification of the notified body authorizing use of the mark.



Lot number



Model Number



Serial Number



Medical Device



European Union Authorized Representative



Temperature limitations for transport



Sterilized using ethylene oxide



Use-by date



Do not reuse



Do not re-sterilize



Do not use if package is damaged



Consult Instructions for Use



UKCA mark of conformity with the identification of the notified body authorizing use of the mark.



Manufacturing Date



Manufacturer



Caution



Warning



Refer to instruction manual/booklet (Mandatory)



MR Conditional



MRI unsafe



Non-ionizing electromagnetic radiation



Standby



Stop



Start



Telemetry status indicator



Session status indicator



Battery condition indicator



Type BF Applied Part



For USA audiences only



Ingress protection rating



Connector



Length



Diameter



Polarity



Quantity



Single sterile barrier with protective packaging



Double sterile barrier



Unique device identifier



Keep dry

Battery Disposal Guidelines

The ReActiv8 Activator is supplied with two AA batteries. The Activator package is labeled in accordance with European Council directives 2002/96/EC and 2006/66/EC. These directives call for separate collection and disposal of electrical and electronic equipment and batteries. Sorting such waste and removing it from other forms of waste lessens the contribution of potentially toxic substances into municipal disposal systems and into the larger ecosystem.

Intended Purpose/Indications for Use

The ReActiv8 System is indicated for bilateral stimulation of the medial branch of the dorsal ramus as an aid in the management of mechanical chronic low back pain associated with multifidus muscle dysfunction, in adults who have failed therapy including pain medications and physical therapy and are not candidates for spine surgery.

Contraindications

ReActiv8 is contraindicated for patients who are:

- Unable to operate the system
 - Impaired shoulder mobility limiting the ability to place the activator antenna over the IPG
 - Evidence of cognitive impairment that limits the patient's ability to operate the device
- Unsuitable for ReActiv8 implant surgery, for reasons such as:
 - The patient has an active infection in the vicinity of the surgical site, or any systemic infection
 - The patient is on blood thinners and unable to be temporarily discontinued for the surgical procedure

Warnings

Electromagnetic Interference (EMI)

Electromagnetic interference from electrical or magnetic fields generated by equipment found in the home, work, medical or public environments may interact with or disrupt the function and operation of ReActiv8. The ReActiv8 system includes features that provide a measure of protection from EMI, and most electrical devices and magnets encountered in a normal day are unlikely to affect the operation of the system. However, sources of strong EMI can result in the following effects:

- Serious patient injury or death, resulting from heating of the implanted components of the ReActiv8 system, leading to damage to surrounding tissue.
- Damage to implantable components, resulting in a loss of function that may require surgical replacement.
- Operational changes to the ReActiv8 IPG, causing it to turn Stimulation ON or OFF (particularly if the IPG is enabled for Magnet use), or to reset, resulting in loss of stimulation and requiring reprogramming.
- Use of non-implantable ReActiv8 system components adjacent to or stacked with other equipment should be avoided because it could result in improper operation. If such use is necessary, this equipment and the other equipment should be observed to verify that they are operating normally.

There are no user replaceable cables with the ReActiv8 system. Use of accessories, transducers and cables other than those specified or provided by the manufacturer of this equipment could result in increased electromagnetic emissions or decreased electromagnetic immunity of this equipment and result in improper operation.

Portable RF communications equipment (including peripherals such as antenna cables and external antennas) should be used no closer than 30 cm (12 inches) to any part of the ReActiv8 system, including cables specified by the manufacturer. Otherwise, degradation of the performance of this equipment could result.

EMI from the following medical procedures or equipment may damage the device, interfere with device operation, or cause harm to the patient. If these procedures are required, follow the guidelines below.

- **Diathermy therapy** – Safety of diathermy with an implanted ReActiv8 has not been evaluated. Do not use short-wave diathermy, microwave diathermy, or therapeutic ultrasound diathermy (all now referred to as diathermy) on patients implanted with a ReActiv8. Energy from diathermy can be transferred through the implanted system and cause tissue damage at the location of the implanted leads, resulting in severe injury or death.

Diathermy should not be used because it may damage the IPG components. This

damage could result in loss of function, requiring additional surgery. Injury or damage can occur during diathermy treatment whether the system is turned on or off. All patients should be advised to inform their healthcare professionals that they should not be exposed to diathermy treatment.

- **Magnetic resonance imaging** – MRI compatibility of the ReActiv8 system is conditional on imaging parameters. Refer to the ReActiv8 System Magnetic Resonance Imaging (MRI) Guidelines.
- **Defibrillation/cardioversion** – When a patient is in ventricular or atrial fibrillation, the first consideration is patient survival. External defibrillation or cardioversion can damage the ReActiv8 IPG. It may also cause induced currents in the leads that can injure the patient. Minimize the current flowing through the ReActiv8 system by following these guidelines:
 - If possible, program the ReActiv8 IPG Mode to OFF.
 - Position the defibrillator paddles as far from the ReActiv8 system as possible.
 - Position the defibrillation paddles perpendicular to the ReActiv8 lead path.
 - Use the lowest clinically appropriate energy output for defibrillation.
 - After defibrillation or cardioversion, verify proper device operation and perform a stimulation test. If an anomaly is detected, corrective actions may include lead repositioning or replacement and/or device reprogramming or replacement.
- **Electrocautery and radio frequency (RF) ablation** – Electro-surgery devices should not be used in close proximity to the ReActiv8 IPG or Lead(s). Contact between a lead and the electrosurgical instrument can cause direct stimulation of a nerve and can result in severe injury to the patient. Electro-surgery devices may also damage the lead or IPG and cause a loss of stimulation.

If electrosurgical cautery or RF ablation cannot be avoided, observe the following precautions to minimize complications:

1. Program the ReActiv8 IPG Mode to OFF.
 2. Avoid direct contact between the cautery equipment or ablation catheter and the implanted ReActiv8 IPG or Leads.
 3. Use a bipolar electro-cautery system if possible.
 4. Use short, intermittent bursts at the lowest possible energy levels.
 5. Verify proper operation of ReActiv8 and perform a stimulation test immediately following the procedure. If an anomaly is detected, corrective actions may include lead repositioning or replacement and/or device reprogramming or replacement.
- **ReActiv8 interaction with other active implantable devices** – Safety of the ReActiv8 system has not been evaluated when used in combination with active implantable devices (e.g. pacemaker, defibrillator, spinal cord stimulation). There may be undesirable interactions between the stimulation pulses of the ReActiv8 system and

the other active implantable device. In the event of a patient requiring both a ReActiv8 System and an active implantable device, physicians involved with both devices (e.g. neurologist, neurosurgeon, cardiologist, cardiac surgeon) should discuss the possible interactions between the devices before surgery.

Other

- **Case damage** – If the ReActiv8 IPG case is pierced or ruptured, severe burns could result from exposure to battery chemicals.



Precautions

- Do not crush, puncture, or burn the IPG – risk of explosion or fire.
- Do not incinerate or cremate the ReActiv8 IPG – risk of explosion.
- Do not reuse any implantable device or implantable accessory after exposure to body tissues or fluids because the functionality of the component cannot be guaranteed.
- Laptop computer battery maintenance or replacement should only be performed by authorised personnel.

Electromagnetic Interference (EMI)

EMI from the following equipment is unlikely to affect the ReActiv8 system if the guidelines below are followed:

- **Computed tomographic X-ray (CT scan)** – If the patient undergoes a CT scan procedure, turn the IPG Mode to OFF. After completing the procedure, restore the desired parameters.
- **High output ultrasound and lithotripsy** – Program the ReActiv8 IPG Mode to OFF. The use of high output ultrasound devices, such as an electrohydraulic lithotripter, may damage the electronic circuitry of an implanted IPG. If lithotripsy must be used, do not focus the energy near the IPG.
- **Electronic article surveillance (EAS)** – EAS equipment such as retail theft prevention systems, as well as airport metal detectors may interfere with the ReActiv8 system. Advise patients to walk directly through an EAS system and not remain near an EAS system longer than necessary.
- **Radiation therapy** – Ionizing radiation produced by high energy radiation sources, such as cobalt 60 or gamma radiation, can damage active implantable medical devices. The effect is cumulative and can vary from temporary modifications to irreversible damage, depending on dose rate and total radiation. Note that this effect may not be immediately detected. If radiation therapy is required, program the IPG to OFF and protect the implanted device with lead shielding. Verify IPG operation after exposure. If tissue near the implant site must be irradiated, IPG relocation should be considered.
- **Static magnetic fields** – Avoid equipment or situations where there is a risk of exposure to static magnetic fields greater than 10 gauss or 1 mT. Sources of static magnetic fields include, but are not limited to, audio loudspeakers, magnetic badges, or magnetic therapy products. If patients cannot avoid magnetic fields, the **Magnet Effect** parameter should be programmed to **None**.
- **Bone growth stimulators** – Safety has not been established for bone growth stimulators in patients who have a ReActiv8. If bone growth stimulators must be used, turn the ReActiv8 IPG Mode to OFF. Keep external magnetic field bone growth stimulator coils as far away from the IPG as possible. When using either an implantable or external bone growth stimulator, ensure that both the bone stimulator and ReActiv8 are working as intended.
- **Diagnostic ultrasound probes** – Turn the ReActiv8 IPG Mode to OFF. Keep the probe away from the IPG. An average acoustic intensity of greater than 500 watts per meter squared should not be used.
- **Electrolysis** – Safety has not been established for electrolysis therapy in patients who have a ReActiv8. If electrolysis must be used, turn the ReActiv8 IPG Mode to OFF. Keep the electrolysis wand as far away from the IPG as possible.

- **Electroconvulsive therapy (ECT)** – Safety has not been established for ECT in patients who have a ReActiv8. Induced electrical currents may cause heating, especially at the lead electrode site, resulting in tissue damage.
- **Transcranial magnetic stimulation (TMS)** – Safety has not been established for TMS in patients who have a ReActiv8. Induced electrical currents may cause heating, especially at the lead electrode site, resulting in tissue damage.
- **Externally-applied monitoring equipment** – Externally-applied patient monitoring equipment, such as an ECG machine or Holter recorder, may detect ReActiv8 stimulation pulses.
- **Explosive or flammable gases** – The Programmer and Activator are not certified for use in the presence of a flammable anaesthetic mixture with air or an oxygen or nitrous oxide rich environment. The consequences of using the programmer near flammable atmospheres are unknown.
- **Electromagnetic field devices** – Exercise care or avoid the following equipment or environments which may affect normal operation of the ReActiv8 system due to strong magnetic, electrical and electromagnetic fields:
 - Antennas of ham radios
 - Antennas of citizens band (CB) radios
 - Cellular phones
 - Wi-Fi® radio equipment
 - Bluetooth® radio equipment
 - Electric arc welding equipment
 - Electric induction heaters used in industry to bend plastic
 - Large electric motors or alternators
 - Electric steel furnaces
 - High-power amateur radio transmitters
 - High-voltage areas
 - Power amplifiers
 - Magnetic degaussing equipment
 - Magnets or other equipment that generates strong magnetic fields
 - Microwave communication transmitters
 - Perfusion systems
 - Resistance welders
 - Television and radio transmitting towers

If it is suspected that equipment is interfering with ReActiv8, the following is recommended:

1. Move away from the equipment or object.
2. If possible, turn OFF the equipment or object.
3. Then, if necessary, use the Magnet or Activator to disable stimulation.
4. Inform the equipment owner or operator of the occurrence.

If the above actions do not resolve the effects of the interference, or there is a suspected change after exposure to EMI, then the patient should contact their physician.

If magnetic fields cannot be avoided, the **Magnet Effect** parameter should be programmed to **None**.

- **Laser procedures** – Turn the ReActiv8 IPG Mode to OFF. Keep the laser directed away from all components of ReActiv8.

Electromagnetic interference (EMI) from household items

Most household appliances and equipment that are working properly and grounded properly will not interfere with ReActiv8. Many household items contain magnets or generate magnetic fields that are strong enough to activate the magnet switch inside the IPG, which can be programmed to start or stop therapy.

If interference is suspected, instruct the patient to move away or turn off the household item.

Target population

ReActiv8 is not suitable for every patient with chronic low back pain. When selecting candidates for ReActiv8, consider the following:

- Chronic low back pain despite medical management and attempting at least one course of physical therapy.
- Able to operate the system.

The safety and effectiveness of the ReActiv8 system has not been established for:

- Pregnant women (including effects on a foetus, or during childbirth)
- Paediatric use (patients under the age of 18)
- Patients with worse leg pain than back pain
- Patients with radiculopathy below the knee

Physician training

- **Implanting physicians** – Implanting physicians must have undergone training on surgical procedures and device implantation.
- **Prescribing physicians** – Prescribing physicians should be experienced in the

diagnosis and treatment of chronic low back pain and should be familiar with using ReActiv8.

Sterilization, storage and handling

- **Package or component damage** – Do not implant a ReActiv8 IPG or Lead if the sterile package or components show signs of damage, if the sterile seal is ruptured, or if contamination is suspected for any reason. Return any suspect components to Mainstay Medical for evaluation.
- **Re-sterilization** – Do not re-sterilize or reuse any devices for any reason, because of risk of infection and malfunction of the devices.
- **Single-use, sterile device** – The sterilized components of the ReActiv8 system and accessories are intended for single use only.
- **Storage temperature** – Store all sterile products, including the IPG, implantable Leads, and accessories, between 5°C and 42°C. Exposure to temperatures outside this range may result in damage.
- **Storage temperature** – Store the following non-sterile products, including the Programmer Wand, Magnet and Activator, between -10°C and +55°C. Exposure to temperatures outside this range may result in damage.
- **Storage humidity** – Store components between 15% and 93% humidity (non-condensing). Exposure to humidity outside this range may result in damage.
- **Storage environment** – Store ReActiv8 components and their packaging where they will not come into contact with liquids of any kind.
- **Operating temperature** – Do not use the Programmer Wand when the air temperature is greater than 40°C or below 10°C. Do not use the Activator when the air temperature is greater than 40°C or below 0°C.
- **Expiration date** – An expiration date (or “use-by” date) is printed on the packaging for sterile products. Do not use the system if the use-by date has expired.
- **Cleaning external system components** – The recommended cleaning process is to use a soft cloth, lightly dampened with distilled water, ethanol (96%) or isopropyl alcohol (98%), to wipe the exterior case of the Activator, Activator Antenna and Programmer Wand as needed. The same technique can be used with a solution of up to a 50% water / 50% bleach mixture. Do not clean with any water solution containing > 50% bleach.
- **Cleaning instructions for laptop computer** – The recommended cleaning process for the laptop computer case and keyboard is to wipe it using a soft, dust-free cloth lightly dampened with distilled water or isopropyl alcohol as needed. The cleaning process for the display is to gently wipe using a dry soft lint-free cloth as needed. Avoid spraying cleaner directly onto the display or keyboard.

System components

- **Component failure** – As with any electronic device, the ReActiv8 might unexpectedly fail or stop working at any time due to a random component fault, battery failure, exposure to extreme environmental interferences or environmental conditions. These factors may reduce device longevity, effectiveness and cause changes in the performance characteristics.
- **Care and handling of components** – Use care when handling system components prior to implantation. Excessive heat, excessive traction, excessive bending, excessive twisting, or the use of sharp instruments may damage and cause failure of the components.
- **Exposure to body fluids or saline** – Prior to connection of the leads to the IPG, exposure of the metal contacts to body fluids or saline can lead to compromised performance. If such exposure occurs, clean the affected parts with sterile, deionized water and dry completely prior to lead connection.
- **System components** – The use of components or accessories from other manufacturers with the ReActiv8 system may result in failure to deliver stimulation, damage to the system and increased risk to the patient.
- **System testing** – The system should always be tested after implantation and before the patient leaves the surgery suite.
- **Battery-powered equipment** – An implanted lead constitutes a direct, low resistance current path to the body. Use only battery-powered devices and instruments when the lead connections are exposed, such as during the implant procedure. Caution should be taken to properly ground all AC powered equipment used in the vicinity of the patient.
- **Protective earth integrity** – Use only battery-powered devices and instruments if the protective earth conductor integrity is in doubt.
- **Electrical isolation during implant** – Do not allow the patient to have contact with grounded electrically powered equipment that might produce electrical current leakage during implant.
- **Infection** – It is important to follow proper infection control procedures. Infections related to system implantation might require that the device be explanted.
- **The Programmer Wand is NOT STERILE** – The ReActiv8 Programmer Wand is not sterile or sterilisable. It should not be placed in the sterile field unless placed in a sterile sleeve.
- **Product materials** – The ReActiv8 system has materials that come in contact or may come in contact with tissue. Potential for an allergic reaction to these materials should be determined before the system is implanted.
- **Programmer Wand USB connection** – The USB connector of the Programmer Wand should not be installed in a USB port capable of delivering greater than 10 W at 5 V.

The Programmer Wand uses less than 0.5 W at 5 V.

- **Laptop computer external connection** – Do not connect any equipment to the laptop computer provided with the ReActiv8 Application Software and Programmer Wand with a separate mains supply connection (an AC powered printer, for example) while the Programmer Wand is connected to the laptop computer.
- **Laptop computer grounding** – To avoid the risk of electric shock, the laptop computer must only be connected to a mains supply (AC power) with protective earth. If protective earth is not available, the laptop computer must be operated on battery power only. Do not tamper with the protective earth connection.
- **Laptop computer and AC adapter** – The AC adapter is designed only to be used with the laptop computer and the provided detachable AC adapter cord. Do not use any other AC adapter with the laptop computer provided with the ReActiv8 Application Software and Programmer Wand. Do not use the AC adapter with any other equipment. Do not use the AC adapter or detachable AC adapter cord if damage is suspected. The laptop computer and AC adapter should be kept 1.5 meters from the operating table.
- **Strangulation by cable** – When operating the Activator, keep the antenna cable away from the neck to avoid strangulation.
- **Equipment modification** – The equipment is not serviceable. To prevent injury or damage to the system, do not modify the equipment. If service is needed, return the equipment to Mainstay Medical.

System implant

- Do not kink, or stretch the lead body, as this may result in damage to the lead and compromise function.
- Do not advance the introducer sheath without the dilator inside the sheath, as this may result in damage and prevent deployment of the lead.
- Do not use surgical instruments (e.g.: forceps) to handle the lead. The forces applied by surgical instruments may compress the lead, resulting in compromised performance and conductor, or insulation damage.
- Do not bend, kink or use surgical instruments on the stylet, which may result in damage. Use care when reinserting a stylet. Too much pressure on the stylet could damage the lead, resulting in intermittent or loss of stimulation.
- Do not use saline or other ionic fluids at or near any of the electrical connections (i.e. lead terminal or IPG header), as this could result in compromised performance.
- Do not place sutures directly around the lead body, since sutures may cut the lead insulation.
- Before opening the lead package, verify the package model number, that the kit is within its expiration (use-by) date, and that the packaging has not been damaged or compromised in any way.
- When removing the lead from the sterile tray, carefully remove the distal end from the retaining tube to avoid damaging the fixation tines. Carefully inspect the lead for damage after removing it from the sterile package.
- If the operating field is contaminated (e.g. with blood) wipe gloves, lead, stylet, and introducer before proceeding with the implant. Failure to do so may result in difficulty placing the lead.
- Do not use long-acting muscle relaxants or paralytics during the anaesthetic procedure as it could suppress muscle contractions during stimulation, confounding system testing.

Programming

- **High stimulation outputs** – Stimulation at high outputs may cause unpleasant sensations. If unpleasant sensations occur, stimulation should be adjusted appropriately.

Activator and Magnet

- **Activator handling** – To avoid damaging the Activator, do not immerse it in liquid; do not clean it with nail polish remover, mineral oil, or similar substances; avoid spilling fluids on it; and do not drop it or mishandle it in a way that may damage it.
- **Magnet disable** – If the ReActiv8 IPG Magnet Effect has been programmed to NONE, the patient must have an Activator to start or prematurely stop Sessions.
- **Magnet may damage items** – Do not place the ReActiv8 Magnet on or near computer monitors, magnetic storage disks or tapes, televisions, credit cards, or other items affected by strong magnetic fields. If the magnet is too close, these items may malfunction or be damaged.

Limitations of use

Patient activity/equipment operation – Please read the following important information about activities to avoid.

- Patients should be advised to avoid activities requiring excessive twisting or stretching, that may put undue stress on the implanted components of the neurostimulation system for the first few weeks after implant.
- Patients should be advised to avoid activities that include sudden, excessive, or repetitive bending, twisting, bouncing, or stretching that may result in stress on the leads which could result in migration or fracture. This can result in loss of stimulation, intermittent stimulation, stimulation at the fracture site, and additional surgery.
- During stimulation, patients should be advised to not operate potentially dangerous equipment, such as power tools, automobiles, or other motor vehicles, to not climb ladders or participate in other activities where postural change or an abrupt movement could alter the perception of stimulation intensity and cause the patient to fall or lose control of equipment or vehicles or injure others.
- **Component manipulation by the patient (Twiddler’s syndrome)** – Patients should be advised to avoid manipulating or rubbing the ReActiv8 through the skin. Manipulation may cause component damage, lead dislodgement, skin erosion, infection.
- **Scuba diving or hyperbaric chambers** – Patients should not dive below 5 meters (16 feet) of water or enter hyperbaric chambers above 1.48 atmospheres absolute (ATA). Pressures below 5 meters (16 feet) of water (or above 1.48 ATA) could damage the ReActiv8 IPG. Before diving or using a hyperbaric chamber, patients should discuss the effects of high pressure with their physician.
- **Skydiving, skiing, or hiking in the mountains** – High altitudes should not affect the ReActiv8 system; however, the patient should consider the movements involved in any planned activity and avoid putting undue stress on the implanted system.
- **Areas with Protective Signs** – Patients should not enter areas protected by warning notices prohibiting entry by people fitted with an implantable device such as a pacemaker.

- **Emergency procedures** – The patient should be instructed to designate a representative (family member or close friend) to notify any emergency medical personnel of their implanted system, if emergency care is required. Each patient will be provided with a Medical Identification Card that will inform emergency medical personnel that the patient has a ReActiv8 implanted. The patient should be advised to use caution when undergoing any procedure that could include RF, microwave ablation, defibrillation or cardioversion.

Component Return and Disposal

When explanting an IPG and/or leads (e.g. replacement, cessation of stimulation, or post-mortem), or when disposing of accessories, follow these guidelines:

- Explanted IPG and lead components may be contaminated with potentially infectious substances of human origin. Always follow hospital procedures and utilize proper biohazard packaging and processes.
- If possible, return the explanted device(s) with completed paperwork to Mainstay Medical for analysis and disposal. Examination of explanted components can provide information for continued improvement in system reliability.
- Do not autoclave any components of ReActiv8 or expose any components to ultrasonic cleaners.
- Dispose of any unreturned components according to local environmental regulations; in some countries, explanting a battery-powered implantable device post-mortem is mandatory.

Residual Risks and Potential Complications

The implantation of ReActiv8 involves risks similar to those of neurostimulators. In addition to risks commonly associated with surgery, implantation or use of ReActiv8 includes, but is not limited to, the following risks:

- Adverse Events (AEs) associated with the surgical procedure, including implant, revision, replacement, and removal, such as prolonged procedure, adverse drug reactions, bleeding, hematoma, bruising, asphyxiation, infection, pain, inflammation, numbness, poor wound healing including wound dehiscence.
- Abandonment of the implant procedure, including due to failure to achieve suitable stimulation thresholds in one or both leads.
- Abandonment of device fragments in the body.
- Accidental injury to adjacent tissues, e.g., piercing structures such as muscle, blood vessels, or organs.
- Acute or persistent pain including more pain than anticipated after surgery, and/or worsened low back pain, and/or pain and discomfort due to presence of the device.
- Infection, including local infection of the surgical site, systemic infection, and sepsis.
- Slow, abnormal, or inadequate wound healing, including wound dehiscence.
- Tissue reaction and/or allergic reaction to the implanted device materials.
- Device extrusion.
- Erosion, threatened erosion, or fistula formation in skin overlying device components.
- Nerve irritation, impingement, or damage, including that resulting from mechanical presence of device, exposure to electricity including electrical stimulation, or migration of the leads, suture sleeve, or IPG. This may lead to pain, paralysis, sensory deficits, or changes to bowel, bladder, or reproductive function.
- Excessive fibrotic tissue growth.
- Stiffness, including restricted motion due to adhesions to the device.
- Tissue damage or irritation due to mechanical presence of device, including hematoma, seroma, cyst, or swelling.
- Undesired sensations such as uncomfortable paraesthesia, numbness, vibration, pressure, prickling, or uncomfortable contraction of the multifidus, or contraction or sensations in muscles other than the target muscle(s).
- Overstimulation of tissue, resulting in symptoms such as painful muscle contraction, paraesthesia, jolts, or shocks. In addition, injuries that occur as a consequence of stimulation, e.g., accidents that occur as a result of being startled.
- Muscle fatigue, spasm, or injury.

- Inability to deliver stimulation, including inadequate doses of stimulation. Sources include lead migration, lead fracture, device malfunction, stimulation threshold drift, or exposure to electromagnetic fields.
- Inability to stop therapy, with possible complications such as anxiety, restriction of movement, pain, muscle fatigue, postural changes, difficulty in walking, sitting, or physical activity.
- Accidents, injuries, body movements, body positions or biological process which lead to device complications. Examples include a fall which may cause damage to the IPG, sit-ups or severe coughing leading to migration of the lead, or fracture of bones leading to device migration or damage.
- Injury to the person with the device as well as injury to other persons, including electrical, mechanical, chemical, and thermal injuries.
- Malfunction of other medical equipment, such as a pacemaker, due to the device.

Patients may also undergo medical and/or surgical intervention (such as revision or explant) to treat the issues identified above.

Potential Benefits

The potential benefits associated with ReActiv8 include:

- Reduction in low back pain;
- Improvement in the ability to handle regular daily activities (reduction of disability and restoration of function); and
- Improvement in quality of life.

Instructions to Patients

Inform the patient about the risks and benefits, implantation procedure, follow-up requirements, and self-care responsibilities associated with the ReActiv8 system.

Provide the patient with instructions, including the User Manual, regarding the operation and care of the ReActiv8 system. Provide guidelines regarding what circumstances the physician should be contacted regarding suspected problems.

MRI Safety Information

Magnetic Resonance Imaging (MRI)



The ReActiv8 Implantable Pulse Generator (IPG) and implantable leads are **MR Conditional** devices with demonstrated safety in the MR environment only within specified conditions.

Direct the patient to consult with their healthcare provider prior to an MR exam and inform MRI site personnel that they have an MR Conditional medical device during MR screening prior to the MR exam.

Obtain the latest MRI Guidelines



Refer to the document *ReActiv8 System Magnetic Resonance Imaging (MRI) Guidelines* for an list of approved MR Conditional components, model numbers and required conditions (including patient preparation) for safe use in the MR Environment. This document may be updated periodically. The latest version of these guidelines may be obtained at www.mainstaymedical.com/resources or through Mainstay Medical with the contact information provided at the beginning of this document. Referring to this document prior to an MRI scan is mandatory.

Failure to follow these guidelines for MRI scans may result in severe patient injury and/or device malfunction.

Device Description

ReActiv8 Overview

The ReActiv8 system consists of an Implantable Pulse Generator (IPG), Leads, surgical tools and accessories, Application Software, Programmer Wand, Activator, Magnet and Tunneler.

The ReActiv8 IPG, Torque Wrench and Leads, and the Mainstay Tunneler have been sterilized using ethylene oxide (EO) gas.

Implantable components of the ReActiv8 system

The implantable components of the ReActiv8 system are:

- Model 5100 ReActiv8 Implantable Pulse Generator
- Model 8145 ReActiv8 Implantable Stimulation Lead and Suture Sleeves – 45 cm
- Model 8165 ReActiv8 Implantable Stimulation Lead and Suture Sleeves – 65 cm

External components of the ReActiv8 system

The external components of the ReActiv8 system are:

- Model 7000 ReActiv8 Activator
- Model 4000 ReActiv8 Magnet
- Model 5500 Torque Wrench
- Version 1.0.1.6 (English) and 1.0.1.9 (Multilanguage) Application Software
- Model 6000 Programmer Wand
- Model TUN1 Mainstay Tunneler

Note: The ReActiv8 Programmer Wand and Application Software are provided with a commercially available laptop computer and AC adapter.

ReActiv8 Implantable Pulse Generator (IPG)

The ReActiv8 IPG is designed to deliver electrical stimulation to nerves. It does not emit ionizing radiation. The electrical signals travel from the IPG, through the leads, to electrodes placed near nerves. The ReActiv8 Activator enables the patient to control delivery of stimulation.

The ReActiv8 IPG is a two-channel, programmable device that accepts two four-electrode leads. The IPG has an epoxy resin header with two suture holes which may be used to secure the IPG to the tissue pocket. The electronics and its power source, a lithium chemistry primary cell (non-rechargeable) battery, are encapsulated in a hermetically sealed titanium can.

There are two lead connectors in the IPG (one for each of the two leads), consisting of four aligned spring contacts that establish the electrical connection with the lead terminal contacts. Each lead is secured by a set-screw engaging an electrically inactive retainer ring on the lead terminal. A torque wrench is included in the IPG package to enable manipulation of the set-screws.

With standard X-ray procedures, the radiopaque code inside the header of the IPG is visible. It identifies the manufacturer and model number of the IPG. For the ReActiv8 IPG, the code has the format **XX MIPG**, where **XX** are the last two digits of the year the ReActiv8 IPG was manufactured. For example, if a ReActiv8 IPG has a manufacturing date of in 2015, the radiopaque code is **15 MIPG**.

ReActiv8 Leads

Each lead comprises a distal end with electrodes, a proximal end with a connector terminal, and a lead body (Figure 1). The distal end contains four platinum iridium electrodes, an inactive end cap and two opposing sets of three-point tines. The tines are located on either side of the most distal electrode. They fold along the lead body during insertion of the lead through the introducer and deploy to engage tissue and secure the lead upon introducer withdrawal. The placement of the tines and their opposing orientations provides bi-directional fixation and is designed to reduce the risk of lead movement.

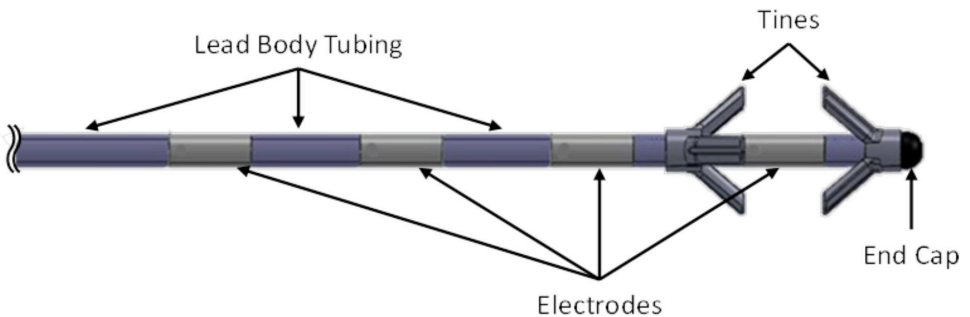

Figure 1: ReActiv8 Lead distal end showing electrodes, tines and end-cap

On the proximal end the lead has four nickel cobalt alloy terminal contacts separated by spacers, and an electrically inactive set-screw retainer (Figure 2). Contacts and electrodes are joined by a lead body consisting of individually coated spiral wound insulated wires, and the whole lead is covered by polyurethane tubing. The lead has a lumen closed at the distal end which accepts a stylet.

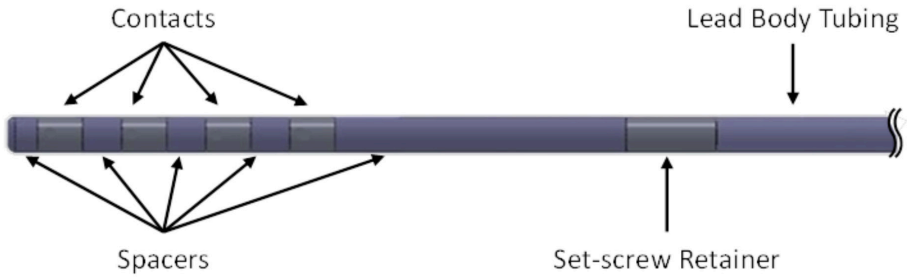

Figure 2: ReActiv8 Lead proximal end showing connector terminals and set-screw retainer

The terminal contacts connect to the aligned spring contacts in the IPG header to establish the electrical connection. Each lead is secured in the IPG by a set-screw engaging the retainer on the lead terminal.

Lead Accessories

The lead is packaged with two accessories: a suture sleeve and a stylet. The stylet is a straight 316L Stainless Steel wire which can be inserted into the lead lumen to provide additional stiffness and ease passage of the lead through the introducer. The suture sleeve (Figure 3) may be used to attach the lead body to the fascia and features a 1.3 mm inner-diameter. The suture sleeve is moulded out of NuSil MED-4870 silicone rubber.



Figure 3: Suture sleeve

Lead Delivery System

The lead is designed to be placed using a commercially available 7Fr Introducer Kit and the Mainstay Model TUN1 Tunneler.

Application Software and Programmer Wand

The Programmer Wand is connected via a USB port to a commercially available laptop computer that contains the ReActiv8 Application software. The laptop computer is configured such that it can only be used with the Application Software. The Programmer Wand communicates with the IPG using short-range inductive telemetry. The Application Software provides a user interface that is used to program the IPG (change the value of the programmable parameters), interrogate the IPG (ask for the actual value of the programmable parameters, battery voltage, logged information and IPG status) and read the lead impedance (command the IPG to perform the procedure that allows it to calculate the lead impedance). Refer to the Programming section for more detailed information.

ReActiv8 Activator

The Activator is a hand-held device that is used to start and stop stimulation and can be used to check the status of the IPG. The Activator is as illustrated in Figure 4. The Activator consists of a control module attached to an antenna via a cable and communicates with the IPG via short-range inductive telemetry. This configuration allows the user to maintain visual contact with the control module during operation while the antenna is placed over the IPG.

The Activator is powered by 2 AA-type alkaline batteries which are user replaceable.

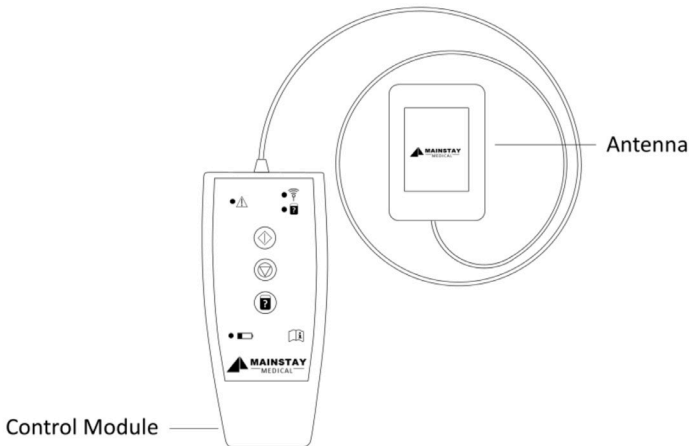

Figure 4: Activator

ReActiv8 Magnet

The Magnet can be used to start and stop stimulation when the IPG is configured for such an action.

Package Contents

ReActiv8 IPG kit

The ReActiv8 IPG kit (Model 5100) contains the following items:

- 1 ReActiv8 Implantable Pulse Generator (Model 5100)
- 1 Torque Wrench

ReActiv8 Lead kit

The ReActiv8 Lead kit (Model 8145 / 8165) contains the following items:

- 1 ReActiv8 Stimulation Lead
- 2 Straight Wire Stylets
- 2 Suture Sleeves

ReActiv8 Activator kit

The ReActiv8 Activator (Model 7000) contains the following items:

- 1 ReActiv8 Activator
- 2 AA alkaline batteries

ReActiv8 Magnet kit

The ReActiv8 Magnet (Model 4000) contains the following item:

- 1 ReActiv8 Magnet

ReActiv8 Torque Wrench

The ReActiv8 Torque Wrench (Model 5500) contains the following item:

- 1 ReActiv8 Torque Wrench

ReActiv8 Programmer Wand

The ReActiv8 Programmer Wand (Model 6000) contains the following item:

- 1 ReActiv8 Programmer Wand

ReActiv8 Application Software

The ReActiv8 Application Software is supplied on a commercially available laptop computer. CE 2797 mark on the laptop computer applies only to the ReActiv8 Application Software (and not to the laptop computer or other software on the laptop computer).

Product Materials

The ReActiv8 system is manufactured with materials that come into contact with tissue.

The following materials are intended to come into contact with tissue:

- Platinum iridium
- Polyurethane
- Silicone rubber
- Stainless steel
- MP35N (alloy)
- Titanium
- Epoxy resin

The ReActiv8 does not contain phthalates, latex, human blood derivatives or cells or tissues of human or animal origin.

A copy of the Summary of Safety and Clinical Performance (SSCP) can be viewed by searching the device brand name on the Eudamed website at <https://ec.europa.eu/tools/eudamed>, when it is available. A copy of the SSCP is also available at www.mainstaymedical.com/resources.

Implant Procedure

Implant Summary

The leads are designed for permanent implant by anchoring the tines on either side of the intertransversarii lateralis lumborum (intertransversarii), with the electrodes placed adjacent to the descending medial branch of the dorsal ramus nerve. The leads are introduced under fluoroscopic visualization using a needle, guide wire, and delivery sheath with dilator.

Leads are placed bilaterally, with the electrodes ideally placed adjacent to the medial branch of the dorsal ramus as it crosses the transverse process at L3. Leads are tunnelled subcutaneously between the lead implant incision and the IPG pocket.

The IPG is placed in a subcutaneous pocket in a location deemed appropriate by the implanting physician, considering the patient's ability to reach the IPG location for initiation of stimulation with the Activator. It is recommended that an appropriate location be used to minimize tensile forces on the lead during subject movement.

Patient Preparation

The patient is preferably positioned prone (face down) on an operating table compatible with fluoroscopy, with the spine, hips and knees in approximately the same position as when the patient is standing (i.e. not flexed).

Using standard sterile techniques, carry out the appropriate skin prepping, draping, and injection of local anaesthetic to perform the percutaneous lead placement.

The patient should be anaesthetized as per the physician's discretion. Long-acting muscle relaxants or paralytics should be avoided during the anaesthetic procedure as it could suppress muscle contractions during stimulation, confounding system testing.

Package Opening / Product Handling

Read the label on the product package before opening to ensure you have the right product. Inspect the package carefully to ensure it is intact. Do not use a damaged or opened package. For products that are provided STERILE, introduce the contents into a sterile field: (1) Peel the Tyvek lid from the outer tray, (2) use a sterile handling technique to put the inner tray into sterile field, and (3) peel the Tyvek lid from inner tray to expose the contents. The product should be stored according to the conditions listed on the individual product labels.

Lead Placement

The leads should be placed with an insertion point near the midline of the body, with a trajectory such that the electrodes are placed near the nerve which is the stimulation target.

1. Identify the insertion point and make a skin incision at the needle-entry site.

NOTE: The incision should be of sufficient length to allow placement of strain relief and a suture sleeve if deemed necessary.

2. Under fluoroscopy, insert the needle (included in the introducer kit). The tip of the needle should be advanced in a straight trajectory to the cranial edge of the transverse process on which the target nerve lies and extend through the intertransversarii to the anterior surface of the transverse process.



CAUTION: Avoid steering the needle to correct for misalignment within the needle tract as this may cause lead migration. If the placement of the needle is not at the desired location, the needle should be removed entirely and the procedure started over.

NOTE: After placement, confirm needle location under fluoroscopy in both anterior-posterior and lateral views.

3. Place the guide wire (included in the introducer kit) through the needle.

NOTE: The guide wire should exit the needle in line with the needle. If it does not, it may be necessary to retract the guide wire into the needle and advance the needle slightly (1-2mm) to get penetration through the intertransversarii.

4. Confirm the guide wire position in both anterior-posterior and lateral views and then remove the needle while holding the guide wire stable.
5. Insert the introducer and dilator over the guide wire, following the same path and trajectory as the guide wire to prevent kinking of the guide wire.
6. Confirm placement in both anterior-posterior and lateral views and then remove the guide wire. Remove the dilator and guide wire from the introducer sheath.
7. Insert the lead with the stylet inserted into the introducer. The distal tip of the lead should be advanced to exit the sheath just beyond the anterior surface of the transverse process.

NOTE: Do not remove the stylet before inserting the lead into the introducer. Without the stylet, lead stiffness may not be sufficient to advance the lead into the correct position.

- Once lead placement is confirmed via fluoroscopy in both anterior-posterior and lateral views, remove the introducer and withdraw the lead stylet from the lead.

NOTE: If the lead does not advance beyond the tip of the introducer, the introducer may not be placed deeply enough. Remove the lead from the introducer and after reinserting the dilator, advance the introducer slightly and reattempt lead placement.



CAUTION: If the lead advances beyond the introducer sheath tip at any point in the procedure and repositioning is determined to be necessary, the lead should not be pulled back into the introducer as this may damage the tines. The introducer should be withdrawn over the lead body and the lead removed by applying gentle axial loading to the lead body, gripping the lead as close to the insertion point as possible.

- Gently tug on the lead body to engage the distal tines on the anterior surface of the intertransversarii and the proximal tines on the posterior surface of the intertransversarii, and to ensure the tines are engaged. If the lead can be easily removed, the tines are not engaged.

NOTE: It should be possible to feel the engagement of the tines, and movement of the lead in both directions should be limited.

- Once the position is confirmed, provide strain relief in the lead body just caudal to the insertion point.
- The provided suture sleeve may be used to anchor the lead.
- Confirm the final lead position fluoroscopically using anterior-posterior and lateral views and by checking impedance and muscle twitch thresholds using the ReActiv8 IPG.



CAUTION: Attempting to slide the suture sleeve over the lead terminal can cause damage to the lead, resulting in intermittent or no delivery of stimulation. The suture sleeve is slit across the full length and designed to be folded open and popped sideways onto the lead body.

NOTE: Refer to the section “Stimulation Testing” in the manual.

- If stimulation thresholds or lead impedances are NOT satisfactory, remove the lead by cutting the sutures around the suture sleeve (if a suture sleeve was used) and remove the lead by applying slow and steady traction on the proximal lead body as close to the insertion point as possible.



CAUTION: If the lead is removed, visually inspect the distal fixation tines for any sign of damage. Do not reuse the lead if damaged.

14. To replace the lead after removal, repeat the lead placement and stimulation testing instructions above.
15. For the second lead, repeat the lead placement and stimulation testing instructions above.

Creating the IPG Pocket

Once both leads are placed and anchored, create a subcutaneous pocket for the IPG.

16. Administer local anaesthetic (if necessary) at the selected IPG pocket site.
17. Make an incision just large enough to allow placement of the IPG.
18. Form the IPG pocket using blunt dissection.



CAUTION: Ensure that the IPG is placed no deeper than 4 cm below the skin and is parallel to the skin with the labelling language facing the skin. If the IPG is too deep or is not parallel to the skin, telemetry may be compromised.

Tunnelling the Lead

1. Once the IPG pocket is created, tunnel the leads subcutaneously from the implant sites to the IPG pocket.

NOTE: A standard subcutaneous tunnelling tool or introducer set can be used to facilitate lead tunnelling, provided the tunnelling tool or introducer are capable of passing the 1.3 mm diameter lead body.

2. Identify the tunnelling route between the lead incision and the IPG pocket.



CAUTION: Avoid sharp bends or kinks when routing the lead, as this may damage the lead and result in loss of stimulation.

3. Assemble the tunnelling tool per the manufacturers' instructions.

NOTE: If bending of the tunnelling tool is required to conform to the patient's contour, identify a tunnelling tool which includes a malleable insert.

4. Insert the tunnelling tool at one incision and tunnel subcutaneously to the other incision.

NOTES:

- Avoid the lower thoracic ribs during tunnelling.
 - If the tunnelling tool does not extend to the lead site, make an intermediate incision.
-
5. Guide the tunnelling tool subcutaneously along the tunnelling route by pushing the skin over the tunnelling tool tip until the tip of the tunnelling tool sheath is exposed at the incision.
 6. Follow the manufacturer's instructions for removal of the installed tunnelling tip and/or tunnelling insert.
 7. Gently insert the proximal end of the lead(s) through the tunnelling tool sheath to the IPG pocket.
 8. Slide the tunnelling tool sheath over the lead and out of the subcutaneous IPG pocket, leaving the lead in place.
 9. Repeat the tunnelling steps above for the second lead (if necessary), following as close as possible to the subcutaneous path of the first lead.

Connecting and Implanting the IPG

- Once tunneled to the IPG pocket, the leads are connected to the IPG. The left channel is numbered 1-4 and the right channel 5-8.
 - The following graphic is provided on the IPG to aid in visualization of lead connection.

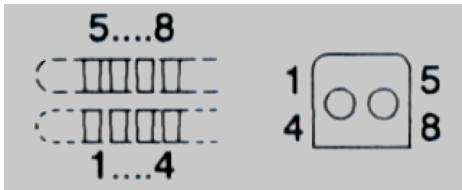

CAUTION: Before connecting the lead to the IPG, wipe off any body fluids and dry all connections. Fluids in the connections may result in stimulation at the connection site, intermittent stimulation, or loss of stimulation.

- Visually verify complete insertion of the lead terminals into the IPG header. The lead terminal contacts should be covered by the IPG contact blocks.

NOTES:

- If the lead will not insert completely, the set-screws may need to be retracted.
 - To retract the set-screws, insert the torque wrench into the seal plug and rotate the set-screws counterclockwise; however, do not remove the set-screws from the connector block.
- Tighten the header set-screws using the provided torque wrench. An audible “click” is the indication of complete engagement of the set-screw. Position the torque wrench at the center depression of the seal plug and turn clockwise while advancing the torque wrench through the seal until engaged with set-screw. Note: A counterclockwise rotation of the torque wrench can result in the set-screw disengaging from the threads. Maintain the torque wrench perpendicular to top surface of the IPG and continue to rotate clockwise. An audible “click” is the indication of complete set-screw engagement.

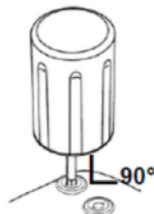

CAUTIONS:



- Tightening the set-screws with the lead not fully inserted may result in insulation and/or conductor damage resulting in intermittent or no delivery of stimulation.
- Only use the torque wrench provided in the IPG package or the Model 5500 accessory. Use of other torque wrenches may induce damage in the lead terminal which could cause insulation or conductor damage and make the system inoperable or prevent removal of the lead terminal from the IPG.
- Ensure that the torque wrench is in line with the screw – do not apply lateral (bending) pressure on the torque wrench as it may lead to damage.
- Prior to placing the IPG in the pocket, gently tug each lead to confirm that the set-screw has secured the lead in place.

4. Once both leads are connected, place the IPG into the pocket. The IPG incorporates two suture holes on the IPG header which may be used to secure the IPG to the fascia.

NOTE: It is recommended to secure the IPG using both suture holes to minimize the risk of IPG rotation, flipping over and migration.

CAUTIONS:



- Do not coil excess leads and leave lying over the IPG between the IPG and the skin. Lead loops should not be smaller than 2.0 cm in diameter. Failure to follow this instruction may lead to potential damage during IPG replacement surgery, potential kinking of the lead, and interference with telemetry.
- Placing the coiled excess leads in a separate pocket formed adjacent to the IPG may reduce the potential for lead/IPG abrasion.

Check System Integrity

1. Prior to closing the incisions, lead placement should again be confirmed using lateral and anterior-posterior (AP) fluoroscopy views and system integrity should be reconfirmed using the Programmer to interrogate the IPG.

NOTE: The IPG should be in the pocket during system integrity checking.



CAUTION: To use the non-sterile Programmer Wand in a sterile field, place a sterile barrier between the patient and the Wand to prevent infection. Do not sterilize any part of the ReActiv8 Programmer or Wand. Sterilization may damage the Programmer or Wand.

2. To ensure proper connection of each lead to the IPG, use the ReActiv8 Application Software to check the battery status, and measure the electrode impedances.

Completing the Implant Procedure

1. After confirmation of acceptable lead placement both radiographically and electrically, close the incisions and dress using routine techniques.

Explant Procedure

In the event that the system needs to be explanted (e.g. as a result of infection), the procedure described below is recommended to remove all implanted components. The procedure can be modified as necessary, for example to remove just the IPG in the event of IPG replacement at end of battery life. Fluoroscopic imaging capabilities may facilitate the procedure.

Removing the IPG

1. With the patient suitably anaesthetized, open the IPG pocket.
2. Cut any sutures securing the IPG to the fascia and dispose of the sutures.
3. Expose the IPG and take it out of the pocket, taking care not to damage or apply tension to the leads.
4. Loosen the set-screws that engage the set-screw retainer on the connector of each lead.
5. Grasp the lead body as close as possible to the IPG header and gently pull the lead terminal from the IPG.
6. Repeat the above step for the second lead.

At this point a new IPG may be connected if required. In this case, refer to the implant section for detailed instructions for procedure completion.

Removing the Leads

1. Open the lead pocket over the area of strain relief on each lead.
2. Gently pull the proximal end of the lead through the subcutaneous pathway previously created to the IPG pocket.
3. Cut any sutures and remove any suture sleeves that secure the leads and dispose, ensuring that no remnants of the sutures or suture sleeves remain in the patient.
4. Dissect any fibrotic tissue that has developed around the strain relief in the lead.
5. Pull on the lead to remove it completely.
6. If more than approximately 1.5 kg of force is required to remove the lead, consider using commercially available extraction tools such as dilator sheaths and locking stylets.
7. Once the leads have been removed, inspect them carefully to confirm that all portions of the lead and the tines have been removed.

8. If in doubt, consider a surgical cut down procedure to examine the implant location.

NOTE: As is required by regulation in most countries, all explanted components should be decontaminated, and returned in a sealed pouch to Mainstay Medical for returned device analysis.

Programming the ReActiv8 IPG

Introduction

The ReActiv8 Application software and ReActiv8 Programmer Wand are supplied with a commercially available laptop computer and are used to program the IPG. The Programmer Wand uses short range inductive telemetry to:

- **Interrogate the IPG** – Obtain the values of the programmable parameters, battery voltage, logged information and IPG status.
- **Program the IPG** – Change the values of the programmable parameters.
- **Measure impedance** – Command the IPG to perform the procedure that allows the Programmer to calculate the lead impedance.

For the purposes of this manual, a programming session is any programming interaction with the IPG, including:

- Interrogating and reviewing the IPG status, program parameters and stored data.
- Permanently programming parameters that control stimulation and diagnostics.
- Changing and temporarily programming parameters to test a stimulation mode.
- Performing system integrity checks and impedance measurements.

Stimulation Parameters

A stimulation session is initiated by application of the Activator. During a stimulation session, the ReActiv8 system delivers episodic electrical stimulation. The detailed timing and stimulation intensity is controlled by the program that was stored in the IPG at the time of programming.

The following IPG parameters (see Figure 5) control the energy (charge) and rate of stimulation:

- **Amplitude** – Controls the stimulation pulse Amplitude.
- **Pulse Width** – Controls the stimulation pulse Width.
- **Rate** – Controls the stimulation Rate.

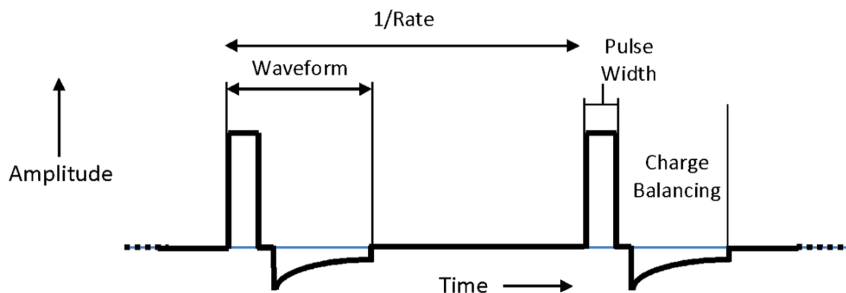

Figure 5: Stimulation waveform and rate

Cycle and session

A Session consists of a number of Cycles of stimulation. Each Cycle of stimulation consists of a number of stimulation pulses at the programmed Amplitude, with a duration of Cycle-On, plus Cycle-Off. During the Cycle-On time, stimulation Amplitude increases linearly from zero to the programmed Amplitude during an On-Ramp, and decreases from the Stimulation Amplitude to zero during an Off-Ramp, as shown in Figure 6.

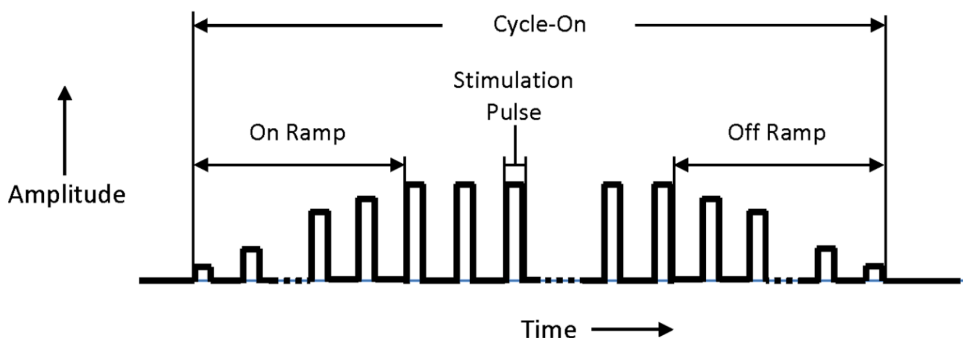

Figure 6: Stimulation Cycle

A session consists of a number of stimulation Cycle-On times, separated by a Cycle-Off time. Stimulation during a session starts after a programmable delay, as illustrated in Figure 7. Stimulation during the session stops automatically once the programmable session time is reached. Stimulation can also be stopped manually using the Activator, or using the Magnet if the IPG is programmed to allow it.

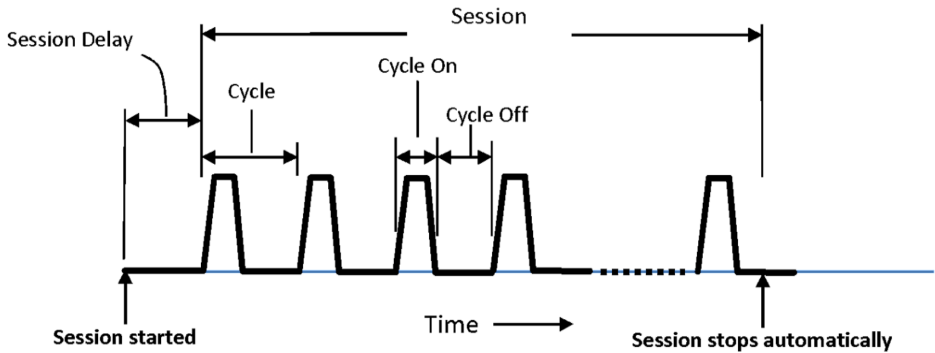

Figure 7: Stimulation Session

Timing of the Session is controlled by the following IPG parameters:

- **Session Delay** – Controls the time between starting the session and the first stimulation pulse.
- **Session** – Controls the duration of the session and is measured from the start of the first Cycle to the end of the last Cycle. The Programmer, Activator or the Magnet can all be used to start or stop a session. Stimulation stops automatically at the conclusion of the Session.
- **Cycle-On** – Controls the duration of each stimulation Cycle.
- **Cycle-Off** – Controls the time between each stimulation Cycle.
- **On-Ramp** – Controls the time over which the stimulation Amplitude reaches its programmed value at the beginning of a Cycle. This allows for a smooth increase in muscle contraction. A sudden increase in stimulation Amplitude may startle the patient or cause temporary discomfort.
- **Off-Ramp** – Controls the time over which the stimulation Amplitude decreases at the end of a Cycle. This allows for a smooth decrease in muscle contraction.

System Diagnostics Data Collection

The IPG records time-stamped data and performs periodic system integrity checks using an internal clock. For each session, the IPG records the following data, which can be downloaded and reviewed using the ReActiv8 Programmer:

- Session start time
- Termination type (session completed, session aborted)
- Duration of stimulation delivery
- Impedance of the active electrode configuration for each stimulation channel
- Battery voltage

The IPG records the following daily session information, which can be downloaded and reviewed using the ReActiv8 Programmer:

- **Total Session Time** (the total number of session minutes for the entire day)
- **Number of Daily Sessions** (the total number of sessions run for the entire day)

The IPG records the following daily measures (if enabled), independent of sessions. This information can be downloaded and reviewed using the ReActiv8 Programmer:

- Battery voltage
- Impedance of the active electrode configuration for each stimulation channel
- Log Impedance Matrix

The basic programmable parameters, their ranges and nominal values are shown in Appendix A - ReActiv8 IPG Programmable Parameters.

Programmer Wand indicators

The ReActiv8 Programmer Wand uses two visual indicators:

- **Standby indicator** – A single green indicator, which lights up when the USB Wand is connected to the laptop computer **and the laptop computer is turned ON.**
- **Signal Strength indicator** – An array of 10 indicators (4 green, 3 yellow and 3 red), which provide information on the quality of the telemetry link.

Preparing the ReActiv8 Programmer Wand and commercially available laptop computer for use

1. Verify that the Programmer Wand is connected to a USB port on the laptop computer.
2. Turn on the laptop computer and login to the Application software.
3. If the laptop computer battery is not charged, connect the AC adapter to the wall outlet (AC mains) and the laptop computer.

NOTE: The software displays an error message if the Programmer Wand has not been connected.

Logging into the ReActiv8 Application Software

After the laptop computer has been switched on, multiple Windows accounts will be available on the screen.

Select the “Commercial” Windows account (the other Windows accounts are not accessible for commercial use).

Navigation, Parameters and Buttons

The ReActiv8 Application Software user interface consists of five main areas of information and control (Figure 8):

1. **Main Window** – Within this window, it is possible to toggle between the five application specific screens by selecting their corresponding Tabs: **Main Program, Temporary Program, Impedance Screen, Data Review and Data Graphs.**
2. **Log Grid** (right upper pane) – Displays the historical log of all the orders issued by the programmer to a specific device.
3. **Constraints Window** (right lower pane) – Displays the error and warning messages corresponding to any unverified restriction or warning condition.

4. **Menu Bar** – All the commands are accessible via the Menu Bar, even if they are also present in other places such as toolbars.
5. **Toolbar** – Provides quick access to frequently used functions.
6. **Information Bar** – Appears on all programmer screens, directly below the screen tabs. Displays Subject ID, Serial No., Battery and Status.

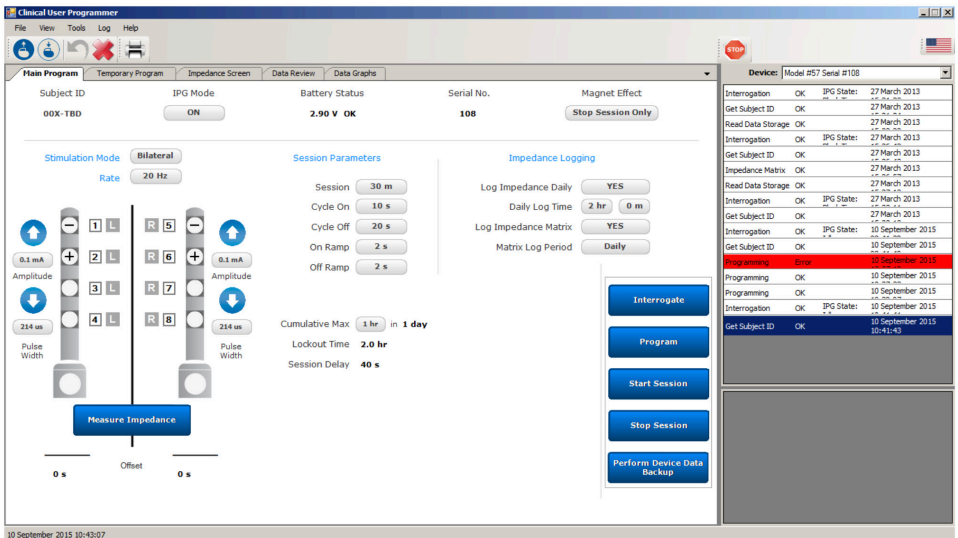

Figure 8: Example of Programmer main window

Main program tab

From this screen, all displayed parameters controlling IPG function can be permanently programmed.

Command buttons

Blue command buttons on the screen perform the following operations:

- **Interrogate** – Imports the parameter values from the IPG into this screen.
- **Program** – Exports the changed parameter from this screen to the IPG. Once parameter changes have been entered on the screen, the Program button flashes until changes are either cancelled or programmed.
- **Start Session** – Starts a Session.

- **Stop Session** (or End key on keyboard) – Stops a Session.
- **Measure Impedance** – Performs the impedance measurement of the active channels.
- **Perform Device Data Backup** – Performs IPG and Programmer data backup.

Indicators are displayed across the top panel in all screens.

Parameter constraints, and warnings







IPG parameters can be selected from a list which appears when clicking the button next to or below the parameter label, for example: 

The font colour in which the parameter selection is displayed indicates the state of that parameter:

- **Black** – The parameter value is currently permanently programmed and not involved in a restriction listed in the **Constraints Window**.
- **Red** – The parameter value is involved in an unresolved restriction (error) listed in the **Constraints Window**, which prevents programming. As a result, the **Program** buttons remain inactive.
- **Orange** – The parameter value is involved in an unresolved warning listed in the **Constraints Window**, which does NOT prevent programming. The blue Program button is flashing.
- **Blue** – The parameter value is not constrained in any way. If no constraints remain elsewhere, the blue Program button is flashing and the parameter can be programmed.

The IPG parameters which are programmable from this screen are discussed in the following sections. Those listed as indicators are fixed settings.

Stimulation mode and configuration

- **IPG Mode** – The IPG can be programmed to **ON** or **OFF**. When **OFF**, it will not deliver stimulation.
- **Magnet Effect** – The response of the IPG to application of the Magnet can be programmed to **Stop Session Only** (only stops an ongoing session (default)), **Start/Stop Session** (starts or stops a session) or **None** (Magnet has no effect on the IPG).
- **Stimulation Mode** – The side and sequence in which stimulation is delivered in a session can be programmed to **Left, Right, Bilateral** (simultaneously), **Sequential Left then Right** and **Sequential Right then Left**.
- **Rate** – Stimulation rate can be programmed to values between **1 and 26 Hz**.
- **Polarity for Terminals 1 - 8** – For each of the electrodes, polarity can be toggled between ‘’ (off), + and - by repeatedly clicking on the Polarity Toggles  in the graphic representation of the Lead terminal.
- **Channels for Terminals 1 - 8** – Each of the electrodes can be assigned to one of the two IPG channels **L** (left) or **R** (right) by clicking on the Channel Toggles next to the terminal number.
- **Polarity for IPG Can (Positive polarity)** – It is possible to include the IPG Can in the stimulation configuration. Polarity can be toggled between ‘’ (off) and + by repeatedly clicking on the Active Can Toggle .
- **Amplitude** – Pulse Amplitude is independently programmable for the left and right channel to **values between 0.0 and 7.0mA**. Alternatively, Amplitudes can be incremented or decremented by clicking the up  and down  arrows.
- **Pulse width** – Pulse Width is independently programmable for the left and right channel to **values between 31 and 336 μ s**.
- **Offset (stimulation channel L&R)** – (Indicator) **in seconds**. A delay for left and right channel delivery of the pulse train.
- **Transpose L-R** – Moves electrodes 1-4 to the right lead image and moves 5-8 to the left lead image on the Programmer screen. Only available on versions 1.0.1.9 onwards.

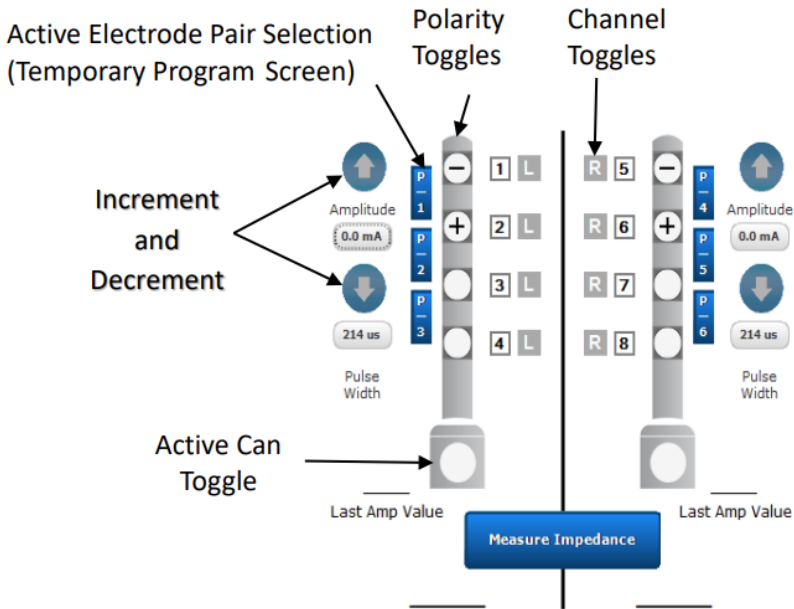

Figure 9: Stimulation configuration controls

Session parameters

- **Session** – The duration of the treatment session is programmable to **values between 1 and 30 minutes**.
- **Cycle-On** – The duration of the cycling pulse train can be programmed to **values between 2 and 20 seconds**. **Cycle-On** includes the programmed **On-** and **Off-Ramp**.
- **Cycle-Off** – The duration of the relaxation phase in between cycling pulse trains can be programmed to **values between 20 and 120 seconds**.
- **On-Ramp** – The time after which the pulse train reaches the full programmed Amplitude can be programmed to **values between 0 and 5 seconds**. This provides a gradual start to each pulse train. **On-Ramp** is included in the **Cycle-On** duration.
- **Off-Ramp** – The time after which the end of pulse train reaches 0mA, measured from the last pulse at full programmed Amplitude. **Off-Ramp** can be programmed to **values between 0 and 5 seconds**. This provides a gradual finish to each pulse train. **Off-Ramp** is included in the **Cycle-On** duration.

- **Cumulative Max** – The maximum cumulative session limit can be programmed to values between **30 minutes to 1 hour** over a time span of **1 day**.
- **Lockout Time** – (Indicator) **2 hours**. The time after a completed session during which stimulation is inhibited.
- **Session Delay** – (Indicator) **40 seconds**. The delay between session activation through the patient Activator and delivery of the first pulse train in the Session.

Impedance logging

- **Log Impedance Daily** – Programmable to **YES** or **NO**. If programmed to **YES**, impedance is logged every day, time specified by the **Daily Log Time**.
- **Daily Log Time** – The time at which the Daily Impedance Log is performed is programmable to a **time between 0:00 and 23:59 hr**.
- **Log Impedance Matrix** – Programmable to **YES** or **NO**. If programmed to **YES**, impedance for all 64 possible electrode permutations is logged periodically during sessions, daily or weekly, as determined by the **Matrix Log Period**.
- **Matrix Log Period** – The frequency at which the Log Impedance Matrix is performed is programmable to: Every Session, Daily or Weekly.

Temporary Program Tab

This tab provides access to the Temporary Programming tool, which is used to test stimulation configurations, thresholds and output settings. This is also the screen used for intraoperative testing.

Temporary mode

While in Temporary mode, the IPG maintains the telemetry link with the Programmer and accepts modifications to the Amplitude, while delivering continuous stimulation (no Cycle-Off time during temporary mode) in Left, Right, or both channels using a Stimulation Pattern from 'Stimulation Mode'. The other parameters can be modified only when the continuous stimulation is not being delivered. When the telemetry link is lost for 5 consecutive seconds, the device will execute an Off-Ramp using the programmed settings and stop the stimulation.

Command buttons

Blue command buttons on the screen perform the following operations:

- **Start Temporary Program** – Initiates an **On-Ramp** using the programmed On-Ramp parameter and the Temporary Programming Parameters, after which it delivers continuous stimulation in both channels if the programmed Stimulation Mode is Bi-lateral, Left if the Stimulation Mode is Left and in channel Right if the Stimulation Mode is Right.
- **Stop Temporary Program** – Initiates an **Off-Ramp** using the programmed Off-Ramp parameter; after the Ramp, the device stops the stimulation. Once the Start Temporary Program button has been pressed, the Stop Temporary Program button flashes until the Stop Temporary Program button or the End key on the keyboard is pressed or if the telemetry connection between the Programmer Wand and the IPG is disconnected for more than 5 seconds.
- **Copy Changed Values to Main Screen** – Copies all the parameter values from the Temporary Program Screen to the Programmer Main Screen.
- **Measure Impedance** – Performs the impedance measurement of the selected terminals.
- **Load Twitch Test Presets** – Loads the starting parameters for Onset Twitch testing.
- **Load Tolerability Test Presets** – Loads the starting parameters for Max Tolerability testing.

The following indicator is displayed:

- **Last Amp Value** – Displays the last value of the Amplitude that was programmed before the Stop Temporary Program button or the End key is pressed. The value shown by this indicator is copied to the Programmer Main Screen when Copy Changed Values to Main Screen button is pressed.

Impedance Screen Tab

The Impedance screen allows real time impedance measurements through the IPG.

Command buttons

Blue command buttons on the screen perform the following operations:

- **Measure Impedance Matrix** – Measures and displays impedance for all 64 possible electrode permutations.
- **Measure Impedance** – Measures the impedance for each channel (L and R if selected) between the active electrodes. Terminal selections (Active Electrodes) in this screen do not affect the Main Program Screen.

Impedance values are displayed according to the following convention:

- <30 Ohms: The label '<30' is displayed in red.
- 30 to 149 Ohms: The measured value is displayed in red.
- 150 to 4999 Ohms: The measured value is displayed in black.
- 5000 to 12000 Ohms: The measured value is displayed in red.
- >12000 Ohms: The label '>12000' is displayed in red.

Data Review Tab

Data Review provides a mechanism for displaying the Data Storage.

Command buttons

Blue command buttons on the screen perform the following operations:

- **Get Stored Data** – Retrieves from the IPG's memory the stored Daily Impedance of the programmed configuration, Logged Impedance Matrices, Total Daily Session Time and the Number of Daily Sessions.
- **Left/Right arrows** – Increments or decrements the Timestamp of the Daily Data Storage displayed.

Impedance values are displayed according to the following convention:

- <30 Ohms: The label '<30' is displayed in red.
- 30 to 149 Ohms: The measured value is displayed in red.
- 150 to 4999 Ohms: The measured value is displayed in black.
- 5000 to 12000 Ohms: The measured value is displayed in red.
- >12000 Ohms: The label '>12000' is displayed in red.

Data Graphs Tab

Data Graphs provides a mechanism to graphically display historical data of **Daily Session Time** and **Daily Impedance** measures in this screen.

Command buttons

The blue command button on the screen performs the following operations:

- **Get Stored Data** – Populates the graphs with the available data of Total Daily Session Time and Daily Impedance retrieved from the IPG's memory.

X-Axis time interval

Selection of the interval displayed on the x-axis is controlled by the Time Window underneath each graph. Using the mouse pointer, grab the slider at each extreme of the window and slide inwards until the desired time interval is displayed.

Log Grid

The Log grid displays the historical log of all the orders issued by the programmer to each specific device.

Constraints Window

The message window displays the error and warning messages corresponding to any unverified restriction or warning condition.

NOTE: If you have trouble understanding errors or warning messages, contact your Mainstay Medical representative for assistance.

Menu Bar

All the available commands are included in the Menu bar, even if they are also present in other places such as toolbars or on the main screen. They are organized in the File, View, Tools, Log and Help menus.







File menu

The **File** menu provides access to a drop-down menu with the following commands:

- **Interrogate** – Retrieves all programmed parameters from the IPG.
- **Program** – Programs all changed parameters into the IPG.
- **Cancel** – Cancels all changed parameters.
- **Undo** – Undoes the last programming command.
- **Open Settings...** – Retrieves values from a saved file.
- **Save Settings...** – Saves current values in a file.
- **Print Settings...** – Print Preview of current parameter values.
- **Exit** – Quits the ReActiv8 Programmer Application.

Tool bar

In the Tool bar, the following commands are represented by Icon buttons.

-  **Interrogate** – Retrieves all programmed parameters from the IPG.
-  **Program** – Programs all changed parameters into the IPG.
-  **Cancel** – Cancels all changed parameters.
-  **Undo** – Undoes the last programming command.
-  **Print** – Launches a Print Preview screen that lists all the programmable parameters.
-  **Emergency Stop** – Stops all IPG stimulation delivery.
- **Flag icon** (upper right corner of screen) - Allows the selection of local languages

View menu

The **View** menu provides access to a drop-down menu allowing configuration of the following user interface options:

- **Status Bar** – When checked, the Status Bar with date and time is shown at the bottom of the screen.
- **Log** – When checked, the Log Grid is shown on the right upper side of the screen.
- **Constraints** – When checked, the Message Window is shown on the right lower side of the screen.
- **Standard toolbar** – When checked, the Program, Interrogate, Undo and Cancel Icons are shown in in the Toolbar.

Tools menu

The **Tools** menu provides access to a drop-down menu with the following commands:

- **Wand Version** – Provides Programmer Wand model, version and serial number.
- **IPG Version** – Provides version information of IPG Telemetry and Therapy firmware.
- **Time** – Allows setting of the device time.
- **Activator Status** – Checks Emulated Activator Status.
- **Activator Start** – Emulates Activator Start.
- **Activator Stop** – Emulates Activator Stop.
- **Reset** – Resets the IPG and the default parameter values are shown on the screen.
- **Read Data Storage** – Reads the IPG statistics and opens a window displaying a table containing the events logged by the device, and for each event its timestamp (format: mm/dd/yy, hh:mm:ss), and the associated information.
- **Export Data Storage** – Exports the Data Storage information to a file of extension ‘.csv’ in the Log folder on the laptop computer.
- **Clear Data Storage** – After user confirmation (“Are you sure to reset the statistics? OK/Close”), resets the device’s counters and recorded events.
- **Reset Blocked Attempts Counter** – After user confirmation (“Are you sure to reset the Blocked Attempts Counter? OK/Close”), resets the device’s blocked attempts counter.
- **Change Language** – Allows the selection of local languages. The Icon is located on the upper right side of the screen.

Log menu

- The Log menu provides access to a drop-down menu with the following data Log management commands:
- **Export Log** – Exports the log information shown in the current Log Grid to a text file.
- **Export Programs** – Exports current programmed settings to a text file.
- **Log filter** – Configures the type of items to be displayed on the log window and to be exported in the log.
- **Compare Programs** – Provides a log of incremental programming changes in subsequent Sessions.
- **Backup Database** – Creates a backup of the log Database in a .backup file.
- **Restore Database** – Restores the log Database from a .backup file previously generated.

Help menu

The **Help** menu provides the following information:

- **About...** – Displays the version of the Programmer Software and the versions of the model library. It also displays the manufacturer’s contact information: Mainstay Medical Limited, contact@mainstaymedical.com.

Information bar

The Information bar appears on all programmer screens, directly below the screen tabs and provides the following information:

- **Subject ID** – Subject identification information. Only available on versions 1.0.1.9 onwards
- **Serial No.** – (Indicator) IPG serial number.
- **Battery** – (Indicator) IPG battery voltage.
- **Status** – (Indicator) IPG Battery Status (OK, ERI (Elective Replacement Indicator), EOL (End of Battery Life).

Interrogation and IPG States

After logging in to the software, interrogate the IPG either by clicking the  icon in the Tool Bar or the blue **Interrogate** button on the **Main Program** screen.

NOTE: Position and hold the Programmer Wand steadily over the IPG during communication between the programmer and IPG.

When interrogation is complete, a pop-up window will display the IPG state and provide pertinent status data when applicable. Also the battery status will be updated.

Close the pop-up window by clicking the **Close to Continue button**.

1. Verify Subject ID (if applicable) and IPG serial number are correct.
2. Ensure Battery Status is OK.
3. Check the Programming Log and Message Panel for any error messages.

IPG States

The following IPG states can be shown in the pop-up window:

- **Safe Mode** – Contact Mainstay Medical Representative. An anomaly was detected and the IPG automatically switched to this mode, which prevents any delivery of stimulation. In the pop-up window, the cause, date and time of the entrance to Safe Mode will be shown.
- **Off** – The IPG Mode Parameter is programmed OFF and the IPG will inhibit stimulation delivery. The Magnet is not detected and Daily Log data are not recorded; however, the IPG is able to deliver commanded impedance measurement stimulation pulses.
- **Idle** – The IPG Mode Parameter is programmed ON and the IPG is ready to start a Session. The Magnet is detected and Daily Log data are being recorded and the IPG is able to deliver commanded impedance measurement stimulation pulses.
- **Session Delay** – The IPG Mode Parameter is programmed ON and the IPG is in the process of starting a Session initiated by the Programmer, Activator or Magnet (if Magnet Effect is programmed to Start/Stop Session Only).
- **In Session** – The IPG Mode Parameter is programmed ON and a session is currently in progress.
- **Lockout Time** – The IPG is in Lockout Time; all sessions are inhibited until the Lockout Time has elapsed. Lockout time starts when a session is over or when the Cumulative Maximum time limit is met or exceeded. A session in progress will be terminated. If a session is terminated prior to completion, only the time stimulation was on during the session will be counted. Temporary Programming stimulation is not affected by this safety mechanism and the stimulation delivered during that mode will not be counted towards the Cumulative Maximum.
- **Temporary Programming** – The device is in Temporary Programming mode. While in this mode, the IPG maintains the telemetry link with the Programmer and accepts modifications in Amplitude while delivering continuous stimulation in Left, Right, or both channels using a Stimulation Pattern from 'Stimulation Mode'. When the telemetry link is lost for 5 consecutive seconds, the device will execute an Off-Ramp using the programmed settings and stop the stimulation.

Stimulation Testing

Stimulation testing is performed to verify Lead integrity and to allow optimization of the programmable Lead configuration and stimulation parameters. During stimulation testing, the patient should be in a prone position. The following stimulation tests may be used.

Interrogate the IPG

Interrogate the IPG either by clicking the  icon in the Tool Bar or the blue **Interrogate** button on the **Main Program** screen.

NOTE: Position and hold the Programmer Wand steady over the IPG during communication between the Programmer and IPG.

Verify IPG–Lead connections

1. Select the **Impedance Screen** Tab.
2. Click on the blue **Measure Impedance Matrix** button and verify that all impedances are within the normal range (150 to 5000 Ohms).

Prepare for stimulation testing

1. Select the **Main Screen** Tab.
2. Set the following parameters:
 - a. **IPG Mode**
 - b. **Stimulation Mode**
 - c. **Right and Left Active Electrodes**

NOTE: The parameter values will be shown in orange font because the Amplitudes are still (intentionally) set to 0.0 mA. This results in a warning that a Session will not be delivered.



3. Click the **Program** button (the parameters values are still in orange and the warning remains).

Perform Threshold testing

1. Select the **Temporary Program** Tab.
2. Set the following parameters:
 - a. **Rate**
 - b. **On-Ramp**



3. Verify the nominal pulse width value is 214 μsec .
4. Click the blue **Start Temporary Program** button.

NOTES:

- The blue Stop Temporary Program button flashes as long as temporary programming is in effect.
 - Temporary programming will be cancelled by clicking the **Stop Temporary Programming** button or the **Emergency Stop** icon in the toolbar, or when the wand is moved away from the IPG for more than 5 seconds.
-
5. Start with one channel by clicking the  or  icons to increment or decrement the stimulation Amplitude until a desired contraction is reached. Click the blue **Stop Temporary Program** button.
 - f. Repeat for the other channel

Stimulation program verification

With the results of the previous test, a bilateral program can be tested.

1. Select the **Temporary Program** Tab.
2. Set-up the following parameters:
 - a. **Stimulation Mode** – *Bilateral*
 - b. **Rate**
 - c. **On Ramp**
 - d. **Off Ramp**
 - e. **Pulse Width** – 214 μsec (unless previously changed)
3. Click the  or  icons on both the left and right channels until a desired contraction is reached and balanced for both channels. Click the blue **Stop Temporary Program** button.
4. Click the blue **Copy Changed Values to Main Screen** button.

Permanently programming the selected parameters

1. Go to the **Main Program** tab and verify that the values have been copied over correctly.
2. Verify that the **Stimulation Parameters** reflect the appropriate session design.
3. Verify that the **Impedance Logging** and Magnet Effect is set-up correctly.
4. Program the new values by clicking the flashing blue **Program** button or the  icon.

Measure impedance and verify IPG time

1. Click Measure Impedance to record the impedance of the active electrode configurations. Verify that the measurements are within the normal range. (If any values are out of range, an error message appears.)
2. Click Tools>Time and verify that the IPG date and time is correct. If the IPG date and time are not correct, contact the Mainstay Medical Representative.

Ending a programming session

At the end of a programming session, make sure that any changes have been programmed prior to completing the session. After completing impedance measurements and checking the programmed IPG date and time, download and review the session and impedance history.

Verify changes have been programmed

1. Select the Main Program tab.
2. Verify that the Program button is not flashing. (A flashing Program button indicates that parameter changes were selected but not programmed.)

Review session history

1. Select the Data Graphs tab.
2. Click Get Stored Data to retrieve data from the IPG.
3. Review Session Time, and Impedance History.
4. Click the Printer icon or click File>Print Settings to open the Print Preview window.
5. In the Print Preview window, verify the following:
 - a. IPG Mode is correct
 - b. Stimulation Mode and parameters are correct
 - c. Impedance Logging settings are correct
 - d. Magnet Effect setting is correct
6. Check the Programming Log and Message Panel for any error messages.

Administering a Session

Using the Activator and Magnet

For instructions on Activator and Magnet function, please refer to the User Manual.

Troubleshooting

This section covers troubleshooting and error messages relating to the Model 65X0 / 75X0 ReActiv8 Programmer.

Telemetry Related Troubleshooting

- “Wand Message” – “Wand disconnected”:
Connect the Programmer Wand to a USB port on the laptop computer. If the Wand is connected to the laptop computer, disconnect the Wand and reconnect the Wand to the laptop computer. Press “Close to Continue” to close the Wand Message window. A new Wand Message window should appear and display “Wand connected”.
- “Wand Message” – “Wand connected”:
The laptop computer has established communication with the Programmer Wand. Press “Close to Continue” to close the Wand Message window.
- “Interrogation Error” – “Communication Lost”:
The Programmer was not able to communicate with the IPG. Make sure the Programmer Wand is placed directly over the IPG and press “Retry”.
- “Order Error” – “Error executing Programming”:
The programmer was not able to transfer all the programmable parameters to the IPG. Make sure the Programmer Wand is placed directly over the IPG.
- “Order Error” – “Error executing Start Session”:
The programmer was not able to command the IPG to start a Session. Make sure the Programmer Wand is placed directly over the IPG.
- “Order Error” – “Error executing Stop Session”:
The programmer was not able to command the IPG to stop a Session. Make sure the Programmer Wand is placed directly over the IPG.
- “Impedance Measure Order Error” – “Order Error”:
The programmer was not able to command the IPG to Measure Impedance. Make sure the Programmer Wand is placed directly over the IPG.
- “Temporary Programming error” – “Communication Lost”
The programmer was not able to command the IPG to Start Temporary Program. Make sure the Programmer Wand is placed directly over the IPG.
- “Impedance Matrix Order Error” – “Order Error”:
The programmer was not able to command the IPG to Measure Impedance Matrix. Make sure the Programmer Wand is placed directly over the IPG.
- “Order Error” – “Error executing Read Data Storage”:
The programmer was not able to command the IPG to Get Data Storage. Make sure the Programmer Wand is placed directly over the IPG.

Changing Programmable Parameters-Related Troubleshooting

- Unable to Program the IPG (the **Program** button is not flashing as expected):
Check the Constraints Window (right lower pane) to see if any error or warning messages corresponding to any unverified restriction or warning condition is present.
Check to make sure the IPG was interrogated prior to programming it.
Verify that the Battery Status is OK.

Programmer Wand Troubleshooting

- During normal operation, the signal strength indicator on the Programmer Wand will flash one of its LEDs approximately once per second when it is within range of the ReActiv8 IPG. If there is an EMI source near the Programmer Wand, multiple LEDs may illuminate simultaneously. If this occurs, move the Programmer Wand away from the current position until the LED indication reverts to flashing approximately once per second when in the range of the ReActiv8 IPG. If the ReActiv8 IPG is not in range of the Programmer Wand, the signal strength indicator should not flash any LEDs.

Activator and Magnet Troubleshooting

For instructions on Activator and Magnet functions, please refer to the User Manual.

Service Information

There are no field serviceable components of the ReActiv8 System. Do not attempt any repair or service yourself.

Please report any serious incident associated with the Mainstay product to your national competent authority and to Mainstay at the following:

Via postal mail:
Mainstay Medical Limited
Clonmel House
Forster Way
Swords, Co. Dublin, K67F2K3
Ireland

Internet: www.mainstaymedical.com
Via email: contact@mainstaymedical.com
Via phone: +353 766 801428

Software Updates – Should a software update be required, Mainstay will contact customers to coordinate the timing and logistics of the update procedure. Mainstay will provide prior written notification to customers prior to any software update. Always verify Mainstay representative credentials prior to allowing access to the ReActiv8 Programmer System.

Radio Equipment (RE)

Hereby, Mainstay Medical declares that for ReActiv8, the radio equipment type – Ultra Low Power Active Medical Implant and its Accessories (operating in the frequency range 9 – 315 kHz) is in compliance with Directive 2014/53/EU. The full text of the EU declaration of conformity is available at the following internet address:
www.mainstaymedical.com

Appendix A: ReActiv8 IPG Specifications

Table 1: ReActiv8 IPG nominal mechanical and electrical specifications

Parameter	Value
Model number	5100
X-Ray identifier	XX MIPG (where XX is replaced with the last two digits of the year of manufacture)
Connector type	Two (2) in-line quadripolar connectors
Height	65 mm
Width	48 mm
Thickness	12 mm
Volume	29.6 cc
Weight	52 g
Can material	Titanium (78.9% of patient contacting surface area)
Header material	Epoxy Resin
Power source	Lithium-Carbon Monofluoride Primary Cell
Storage temperature	0 to 45°C

Table 2: ReActiv8 IPG Programmable Parameters

Parameter	Programmable range			Nominal value
	Minimum value	Maximum value	Step	
Channel for Terminals 1 - 8	Left, Right			Left: T1 - T4 Right: T5 - T8
Polarity for Terminals 1 - 8	Positive, Negative, Disconnected			Disconnected
Channel for IPG Can (+ polarity)	Left, Right, Left and Right, Disconnected			Disconnected
Amplitude	0.0 mA	7.0 mA	0.1 mA	0.0 mA
Pulse Width	31 μ s	336 μ s	31 μ s	214 μ s
Rate	1 Hz	26 Hz	1 Hz	20 Hz
On-Ramp	0 s	5 s	1 s	2 s
Off-Ramp	0 s	5 s	1 s	2 s
Cycle-On	2 s	20 s	2 s	10 s
Cycle-Off	20 s	120 s	2 s	20 s
Session	1 m, 2 m, 5 m, 10 m, 15 m, 20 m, 25 m, 30 m			30 m
IPG Mode	On, Off			Off

Parameter	Programmable range			Nominal value
	Minimum value	Maximum value	Step	
Stimulation Mode	Left, Right, Bilateral, Seq. L-R, Seq. R-L			Bilateral
Magnet Effect	Start/Stop Session, Stop Session Only, None			Stop Session Only
Cumulative Max	30 m, 40 m, 1 hr			1 hr
Daily Log Time	0 hr 0 m	23 hr 59 m	0 hr 1 m	2 hr 0 m
Log Impedance Matrix	YES, NO			YES
Matrix Log Period	Each Session, Daily, Weekly			Daily
Subject ID	12 characters (alpha numeric including "-")			-
Transpose L-R	YES, NO			NO

Table 3: Battery indicators

Battery voltage measurements are done by the IPG to allow assessment of battery condition. The battery status indicators would be defined according to the battery voltage. The battery status indicators and behaviour of the IPG are shown in the following table:

Status	Description	Battery voltage	IPG Behaviour
OK	Battery OK	>2.65 V	Normal operation
ERI	Elective Replacement Indicator	>2.5 and ≤2.65 V	Normal operation Alert sent to the Activator
EOL	End Of Battery Life	≤2.5 V	Idle state, Session inhibited Alert sent to the Activator
		≤2.1 V	Reset condition

NOTE: The estimated time to reach EOL battery status after reaching ERI battery status is at least 45 days, given the maximum conditions stated in Table 5.

Table 4: IPG longevity

Under the conditions summarized in the table below, and assuming two 30-minute Sessions delivered daily, longevity of the IPG is expected to be 5 years or more.

IPG Condition	Estimated Longevity
Using nominal parameters (see table 5)	>5 years
Using maximum parameters (see table 5)	5 years

The IPG longevity estimate includes 2 years of shelf life.

Table 5: Conditions for longevity calculations

Parameter	Nominal value	Maximum value
IPG Mode	ON	ON
Amplitude	5.0 mA	7.0 mA
Pulse Width	214 μ s	336 μ s
Rate	20 Hz	20 Hz
Cycle-On	10 s	10 s
Cycle-Off	20 s	20 s
On/Off-Ramp	2 s	2 s
Session (2x Daily)	30 min	30 min
Stimulation Mode	Bi-lateral	Bi-lateral
Load impedance for each channel	1000 Ohms	1000 Ohms

Appendix B: Programmer Wand Specifications

Table 6 provides specifications for the ReActiv8 Programmer Wand.

Table 6: Programmer Wand nominal specifications

Item	Specification
Power source	Powered by USB connection to Programmer computer
USB cable length	2.5 m
Operating temperature	10°C to +40°C
Storage temperature	-20°C to +70°C
Size	14.0 cm x 6.3 cm x 3.1 cm
Weight	250 g
Expected service life	5 years

Appendix C: ReActiv8 Lead Specifications

Each Lead has four electrodes, two sets of tines and an inactive end cap on the distal end (Figure 11), and a four-contact isodiametric terminal and the inactive set-screw retainer on the proximal end (Figure 10). Terminals and electrodes are joined by individually coated spiral wound wires covered by polyurethane tubing. A lumen in the lead enables the use of a stylet.

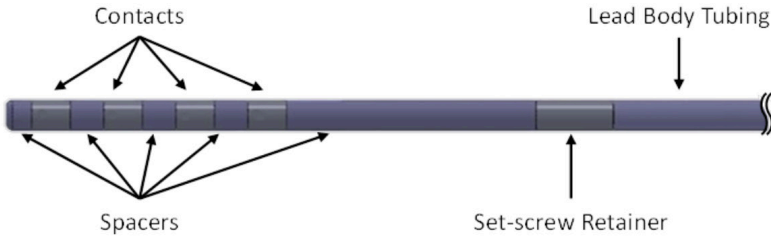

Figure 10: Lead – proximal end

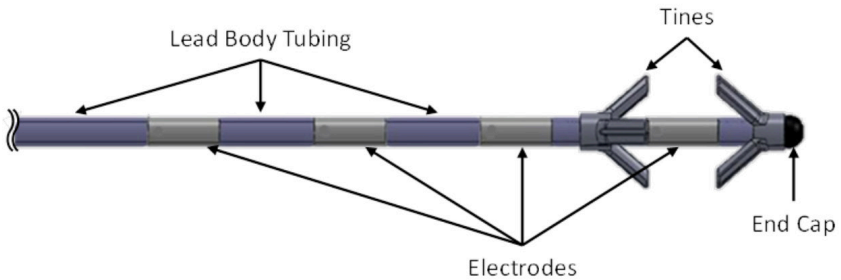

Figure 11: Lead – distal end

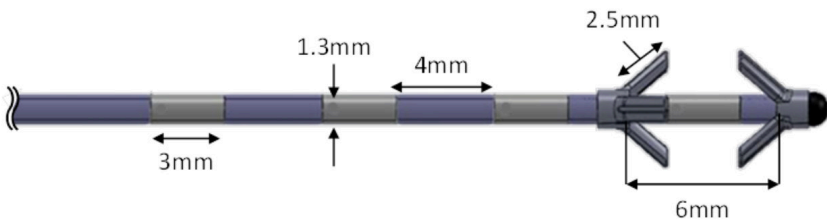

Figure 12: Lead dimensions – distal end

Table 7: Lead summary specification

Parameter	Specification
Lead lengths available	45 cm and 65 cm
Lead body diameter	1.2 mm
Lead lumen	Min 0.4 mm inner diameter
Terminal configuration	1.3 mm diameter – 2.8 mm pitch
Electrode dimensions	1.3 mm diameter – 3 mm length – 12 mm ² surface area
Electrode spacing	4 mm
Tines	3-point tines
Tine spacing	6 mm
End cap	Closed / Full Radius

Table 8: Lead materials

Component	Material	Material contacts human tissue	Percentage (%) of patient contacting surface area*
Terminal contacts and set-screw retainer	MP35N	Yes	1.3% - 1.7%
Terminal spacer	Pellethane 2363-75D	Yes	2.1% - 2.8%
Lead body tubing	Pellethane 2363-90A	Yes	72.7% - 79.8%
Conductor coil	Polyimide coated DFT/MP35N 25% Ag	No	N/A
Electrode	90/10 Platinum/Iridium	Yes	1.7% - 2.3%
Tine component	Pellethane 2363 90A	Yes	2% - 2.8%
End cap	316L Stainless Steel	Yes	0.1% - 0.2%
Suture sleeve	NuSil MED-4870	Yes	13% - 17.6%
Stylet	316L Stainless Steel	No	N/A

* Patient contacting surface area varies based on Lead Model.

Appendix D: Declarations

IPG and Activator declaration

This device complies with part 15 of the FCC Rules.

This Category II radio-communication device complies with Industry Canada Standard RSS-310.

Ce dispositif de radiocommunication de catégorie II respecte la norme CNR-310 d'Industrie Canada.

Operation is subject to the following two conditions:

1. This device may not cause interference.
2. This device must accept any interference, including interference that may cause undesired operation of the device.

The Programmer Wand and Activator are classified as a TYBE BF APPLIED PART per IEC60601-1:2005.

The IPG, Programmer Wand and Activator communicate at approximately 21 kHz. They transmit using amplitude modulation. The transmit bandwidth is about 600 Hz. The receive bandwidth is 10 kHz to 28 kHz. The transmit power is less than 2.0 dB μ A/m at 3 meters.

The Programmer Wand and Activator provide a means for the user to stop stimulation output of the IPG when desired. To avoid any potential interruption to this essential function, follow the EMI warnings, precautions and environment guidance described in this document.

All necessary instructions for maintaining Basic Safety and Essential Performance (e.g., essential function) during the expected service life of the ReActiv8 system are included in this document.

Table 9: Declarations – Activator Electromagnetic emissions

Guidance and manufacturer's declaration – electromagnetic emissions	
The Activator is suitable for use in a Home Healthcare Environment: a dwelling in which patient lives or other places where patients are present (e.g., car, bus, train, boat, plane, outdoor settings).	
Emissions test	Compliance
Radiated RF emissions CISPR 11	Complies (Class A, Group 1)
Conducted RF emissions CISPR 11	Not applicable
Harmonic distortion IEC 61000-3-2	Not applicable
Voltage fluctuations / flicker emissions IEC 61000-3-3	Not applicable

Table 10: Declarations – Programmer Wand Electromagnetic emissions

Guidance and manufacturer's declaration – electromagnetic emissions	
The Programmer Wand is intended for use in a Professional healthcare facility environment. Areas near high frequency surgical equipment and inside the RF shielded room with equipment for magnetic resonance imaging are excluded.	
Emissions test	Compliance
Radiated RF emissions CISPR 11	Complies (Class A, Group 1)
Conducted RF emissions CISPR 11	Complies (Class A, Group 1)
Harmonic distortion IEC 61000-3-2	Complies (Class A)
Voltage fluctuations / flicker emissions IEC 61000-3-3	Complies

NOTE 1: The laptop computer supplied with the Programmer Wand contains an internal battery. If interference is suspected disconnect the laptop AC adapter from the AC outlet.

NOTE 2: The emissions characteristics of this equipment make it suitable for use in industrial areas and hospitals (CISPR 11 class A). If it is used in a residential environment (for which CISPR 11 class B is normally required) this equipment might not offer adequate protection to radio-frequency communication services. The user might need to take mitigation measures, such as relocating or re-orienting the equipment.

Table 11: Declarations – IPG and Activator Electromagnetic immunity

Guidance and manufacturer’s declaration – electromagnetic immunity		
<p>The IPG is an active medical device which is intended to be totally implanted into the human body.</p> <p>The Activator is suitable for use in a Home Healthcare Environment: a dwelling in which patient lives or other places where patients are present (e.g., care, bus, train, boat, plane, outdoor settings).</p>		
Immunity test	Test level	Compliance level
Electrostatic discharge (ESD) IEC 61000-4-2	IPG ±2 kV, ± 4 kV contact ±2 kV, ± 4 kV, ±8 kV air Activator ±8 kV contact ±2 kV, ± 4 kV, ±8 kV, ±15 kV air	IPG ±2 kV, ± 4 kV contact ±2 kV, ± 4 kV, ±8 kV air Activator ±8 kV contact ±2 kV, ± 4 kV, ±8 kV, ±15 kV air
Power frequency (50/60 Hz) magnetic field IEC 61000-4-8	Activator 30 A/m 50 Hz or 60 Hz	Activator 30 A/m 50 Hz

Table 12: Declarations – Programmer Wand Electromagnetic immunity

Guidance and manufacturer's declaration – electromagnetic immunity		
<p>The Programmer Wand is intended for use in a Professional healthcare facility environment. Areas near high frequency surgical equipment and inside the RF shielded room with equipment for magnetic resonance imaging are excluded.</p>		
Immunity test	Test level	Compliance level
Electrical fast transient/burst IEC 61000-4-4	± 2 kV 100 kHz repetition frequency (for Input a.c. power)	± 2 kV 100 kHz repetition frequency (for Input a.c. power)
Surge IEC 61000-4-5	Line-to-line: + 0.5 kV, + 1 kV Line-to-ground: + 0.5 kV, + 1 kV, + 2 kV	Line-to-line: + 0.5 kV, + 1 kV Line-to-ground: + 0.5 kV, + 1 kV, + 2 kV
Voltage dips and interruptions IEC 61000-4-11	Voltage dips: 0 % UT; 0.5 cycle At 0°, 45°, 90°, 135°, 180°, 225°, 270° and 315° 0 % UT; 1 cycle and 70 % UT; 25/30 cycles Single phase: at 0° Voltage interruptions: 0 % UT; 250/300 cycle	Voltage dips: 0 % UT; 0.5 cycle At 0°, 45°, 90°, 135°, 180°, 225°, 270° and 315° 0 % UT; 1 cycle and 70 % UT; 25/30 cycles Single phase: at 0° Voltage interruptions: 0 % UT; 250/300 cycle
Power frequency magnetic field IEC 61000-4-8	30 A/m 50 Hz or 60 Hz	30 A/m 50 Hz

NOTE: U_T is the a.c. mains voltage prior to application of the test level.

Table 13: Declarations – IPG, Programmer Wand and Activator Electromagnetic immunity

Guidance and manufacturer's declaration – electromagnetic immunity		
The IPG, Programmer Wand and Activator are intended for use in the electromagnetic environment specified below. The customer or the user of the IPG, Programmer Wand and Activator should assure that they are used in such an environment.		
IMMUNITY test	Test level	Compliance level
<p>Conducted disturbances induced by RF fields IEC 61000-4-6</p>	<p>Programmer, Activator 0.15-80MHz 1kHz 80% AM 3 Vrms</p> <p>and</p> <p>Activator ISM/Amateur Bands 1kHz 80% AM 6 Vrms</p>	<p>Programmer, Activator 0.15-80MHz 1kHz 80% AM 3 Vrms</p> <p>and</p> <p>Activator ISM/Amateur Bands 1kHz 80% AM 6 Vrms</p>
<p>Radiated RF EM fields IEC 61000-4-3</p>	<p>IPG 80-6000 MHz 1kHz 80% AM 3 V/m</p> <p>Programmer 80-2700 MHz 1kHz 80% AM 3 V/m</p> <p>Activator 80-2700 MHz 1kHz 80% AM 10 V/m</p>	<p>IPG 80-6000 MHz 1kHz 80% AM 3 V/m</p> <p>Programmer 80-2700 MHz 1kHz 80% AM 3 V/m</p> <p>Activator 80-2700 MHz 1kHz 80% AM 10 V/m</p>
<p>Proximity fields from RF wireless communications equipment IEC 61000-4-3</p>	<p>Programmer, Activator See IEC 60601-1-2:2014, Table 9 for proximity fields test limits</p>	<p>Programmer Performance criteria passed with IEC 60601-1- 2:2014, Table 9 limits</p> <p>Activator Performance criteria passed with IEC 60601-1- 2:2014, Table 9 limits with test frequency 385 MHz at 28 V/m</p>

Index

Activator	5, 25, 28	Electronic article surveillance, EAS	13
Cable	18	Laser procedures	15
Kit	29	Lithotripsy	13
Precautions	20	Magnetic resonance imaging	10
Specifications	71	Radiation therapy	13
Amplitude	41, 42	Radiofrequency ablation	11
Antenna	28	Static magnetic fields	13
Batteries		Ultrasound	13
Activator	28	Expiration date	16
Disposal	9	Explantation	39
Indicators	66	Exposure to fluids	17
Battery-powered equipment	17	Hiking	20
Cardiac devices, implanted	11	Hyperbaric chambers	20
Cautions	12	Impedance	50, 51, 60
Components		Implantable pulse generator	5, 25, 29
Care	16, 17	Code	26
Damage	16	Connecting	36
Disposal	21	Creating the pocket	34
External	25	Kit	29
Failure	17	Placement	31
Implantable	25	Power source	25
Non-ReActiv8	17	Implantation	
Contraindications	9	Anaesthetic	31
Damage		Checking system integrity	37
Case	12	Completing the procedure	38
Components	16	Electrical isolation	17
Package	16	IPG pocket	34
Device description	25	IPG, connecting and implanting	36
Diathermy therapy	10	Package inspection	31
Electroconvulsive therapy, ECT	14	Patient preparation	31
Electromagnetic interference, EMI	9, 13	Precautions	19
Bone growth stimulators	13	Procedure	31
Cardioversion	11	Sterility	31
Computed tomography, CT	13	Tunnelling the lead	35
Defibrillation	10	Indication	5
Diathermy	10	Indicators	
Electrocautery	11	Batteries	66
Electrolysis	13	Signal strength	45
Electromagnetic field devices	14	Standby	45

Infection, control	17	System manipulation	20
Instructions to patients	23	Pregnancy	15
IPG. See Implantable pulse generator		Product materials	17, 30
Label symbols	7	Programmer	5, 25, 28, 45
Leads	5, 25, 26	External connection	18
Accessories	27	Grounding	18
Delivery system	27	Impedance measurement	41
Distal end	26	Interrogation	41
Kit	29	Preparation for use	45
Placement	31	Programming, IPG	41
Proximal end	26	Programmer Wand	28
Specifications	69	Indicators	45
Tunelling	35	USB connection	17
Magnet	5, 25, 29	Programming	41
Kit	29	Amplitude	41
Precautions	20	Buttons	42
Magnetic resonance imaging, MRI	10	Command buttons	45
Patient activities	20	Connections	58
Precautions	12	Constraints window	53
Activator	20	Cycle-on	42
Components	17	Data graphs	53
Electromagnetic interference	13, 15	Data review	52
Emergency procedures	21	Diagnostics recording	44
Equipment operation	20	Ending a session	60
Handling	16	Help menu	56
Hiking	20	Impedance	50, 51, 60
Hyperbaric chambers	20	Interrogation	56
Implantation	19	IPG interrogation	58
Magnet	20	IPG states	56, 57
Monitoring equipment	14	Log grid	53
Patient activities	20	Log menu	55
Programming	19	Main program tab	46
Scuba diving	20	Menu bar	53
Skiing	20	Navigation	45
Skydiving	20	Off-ramp	42
Specific populations	15	On-ramp	42
Sterility	16	Parameters	44, 45, 47 49
Storage	16	Permanent programming	59
		Precautions	19

Program verification	59	Parameters	49
Pulse width	41	Timing	43
Rate	41	Skiing	20
Stimulation mode	48	Skydiving	20
Stimulation settings	41	Specifications	
Stimulation testing	58	Implantable Pulse Generator	65
Temporary mode	50	Leads	69
Temporary program tab	50	Programmer Wand	68
Threshold testing	58	Sterility	
Tool bar	54	Programmer Wand	17
Tools menu	55	Stimulation cycle	42
View menu	54	Stimulation testing	58
X-Axis time interval	53	Storage	
Protective earth integrity	17	Environment	16
ReActiv8		Humidity	16
Battery indicators	66	Stylet	27
Lead materials	70	Suture sleeve	27
Lead specifications	69	System testing	17
Nominal conditions	67	Temperature	
Programmable parameters	65	Operating	16
Specifications	65	Storage	16
Re-sterilization	16	Torque wrench	29
Risks	22	Training requirements	6
Scuba diving	20	Transcranial magnetic stimulation, TMS	14
Session	5, 41, 42	Troubleshooting	61
Administering	60	Activator	62
Cycle-off	42	Changing programmable	
Cycle-on	42	parameters	62
Ending	60	Magnet	62
History	60	Programmer Wand	62
Off-ramp	42	Telemetry-related	61
On-ramp	42	Warnings	9
		Diathermy	10
		Electromagnetic interference	9

